

We are very pleased that you decided to purchase this product from SWAROVSKI OPTIK. If you have any questions, please consult your specialist dealer or contact us directly at WWW.SWAROVSKIOPTIK.COM.

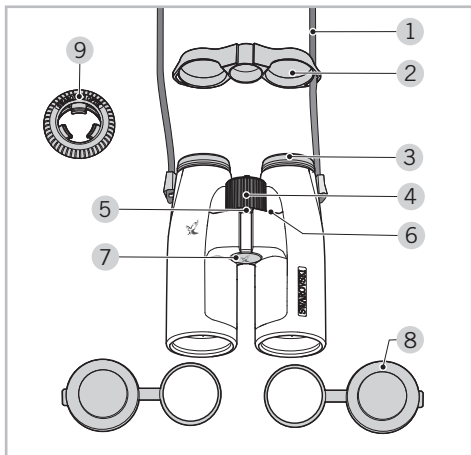

- | | |
|--------------------------|--|
| 1 Carry strap | 6 Dioptic zero point |
| 2 Eyepiece cover | 7 Covering for the tripod connector thread |
| 3 Screw-in-type eye cups | 8 Objective lens cover |
| 4 Focusing wheel | 9 Snap Shot Adapter |
| 5 Dioptic scale | |

Please find our current product accessories at WWW.SWAROVSKIOPTIK.COM.

For your safety!

⚠ WARNING!



Never look at the sun with the binocular! This leads to injury of your eyes!



Never look through the binocular when walking! You could encounter obstacles!

General information

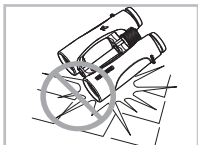

Please protect your binoculars from jolts and jars.

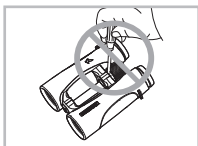

Repairs should be carried out only by authorized workshops.

Attaching the lift carrying strap

- Ⓐ Assembly with eyepiece cover attached on one side (recommended).
- Ⓑ Alternatively: with eyepiece cover attached on both sides.

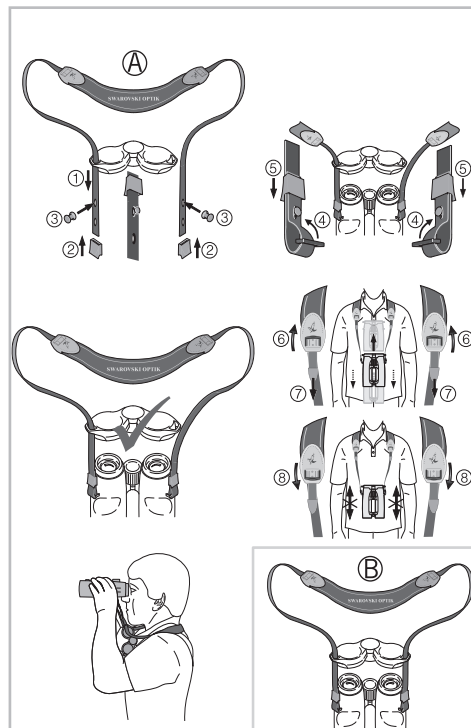

Operation

Adjustment of the screw-in-type eye cups

Use without eyeglasses:

Basically, there are two different adjustment positions available with different distances between the eye and the lens. This allows you to adjust the eye cups individually to your personal preference.

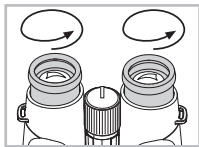

Pos. A: Turn both eye cups (counter-clockwise) until they stop – position A.

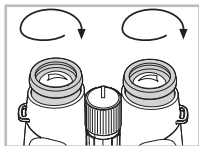

Pos. B: Position B is reached by turning both eye cups clockwise.

Use with eyeglasses:

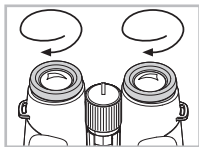

Pos. C: Turn both eye cups clockwise until they stop.

Adjustment of interpupillary distance

To see a single round image, turn the two halves of the binoculars until no irritating shadows can be seen.

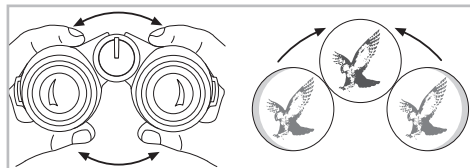

Adjustment of focusing

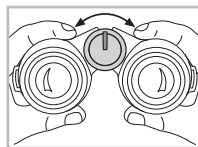

It is possible to bring every subject into focus from the shortest adjustment distance (see Technical Data Sheet) to infinity by turning the focusing wheel.

In the infinity position the little nose of the focusing wheel is at the top.

Dioptic compensation

To achieve optimal image quality, the possibly varying visual acuity between the left and right eye must be corrected.

Use with equal acuity of both eyes:

1. Pull the focusing wheel outwards.
2. By turning the focusing wheel, set the dioptic scale to "0".
3. Push the focusing wheel back in.

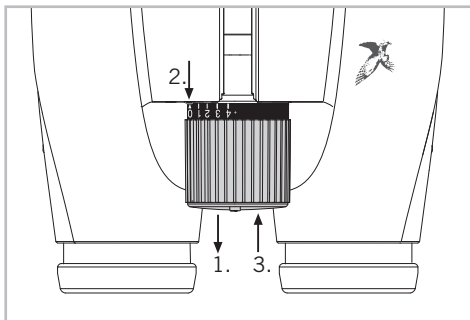
**Use with varying acuity of both eyes:**

1. Look through the left ocular with your left eye and turn the focusing wheel to focus sharply on a selected object.
2. Pull the focusing wheel outwards.
3. Now look at the same object through the right ocular with your right eye and again adjust the focusing wheel to attain optimal clarity.

4. Press the focusing wheel back in again.

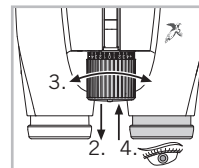
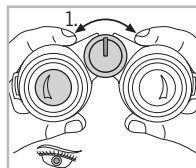

Please note your personal dioptic value on the dioptic scale.

Tripod connector

Remove the covering for the tripod connector thread on the underside of the binoculars using a small coin. To mount the binoculars on a tripod, you will need the tripod connector, which is sold separately as an accessory.

Use of the Snap Shot Adapter

Refer to dedicated Operating Instructions or WWW.SWAROVSKIOPTIK.COM.

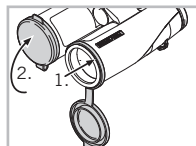
Assembly instructions for objective lens cover

Maintenance and care

Lens-cleaning cloth

You can clean high sensitive lens surfaces with the enclosed special cloth made of micro-fibres. It is suitable for objective lens, ocular lens and eye-glasses.

Please keep the cloth clean, as dirt can damage the lens surface. If the cloth gets dirty, it can be washed in luke-warm soapy water and air-dried. Please use it exclusively for cleaning lens surfaces!

Cleaning

We have designed all elements and surfaces to require little care. To ensure the long-lasting optical brilliance of your binocular, you should keep the glass surfaces free of dirt, oil and grease. When cleaning the lenses, first remove larger particles with an optical lens brush. For the subsequent thorough cleaning we recommend breathing onto the lens surface to form a coat of condensation and then cleaning it with a soft, moist cloth. The housing is best cleansed with a soft, moist cloth (don't use the lens-cleaning cloth).

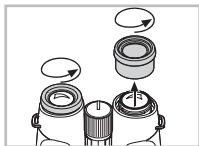

In the event of hard-to-remove dirt (e.g. sand) the eye cups can be unscrewed and cleaned very easily.

Storage

You should keep your binocular in its bag in a well-ventilated, dry place.



If the instrument is wet, it must be dried prior to storage.

In tropical regions or regions with a high degree of humidity the best place to store the instrument in is an air-tight receptacle along with a moisture-absorbing agent (e.g. silica gel).

SWAROVSKI OPTIK patents USA:

- Eyepiece cover: US 6,179,427 B1
- Snap Shot Adapter: US 2009/0128934 A1

All data are typical values.

We reserve the right to make changes regarding design and delivery.
We accept no liability for printing errors. BA-691-01, 03/2010