

# MR762A1

## OPERATOR'S MANUAL



**HK**<sup>®</sup>  
HECKLER & KOCH

**Covering MR762A1**  
**7.62 x 51 mm Rifle**

## SAFETY PRECAUTIONS

---

### CAUTION: Read these safety rules before handling the firearm!

---

Read this operators manual before handling your firearm. The following safety rules are placed in this manual by HK as an important reminder that firearms safety is your responsibility. If handled improperly firearms can be dangerous and can potentially cause damage to property, serious injury, or death.

1. Never point a firearm at anyone, or in any direction other than a SAFE direction, i.e. downrange.
2. Treat all firearms as if they are always loaded.
3. Keep your finger off the trigger and outside of the trigger guard until your sights are aligned on the target.
4. Keep your finger off the trigger and outside of the trigger guard while loading or unloading the firearm.
5. Keep your finger off the trigger and outside of the trigger guard while slinging the firearm or while carrying it.
6. Be sure of your target and the back stop beyond.
7. Never give a firearm to or take a firearm from anyone unless the action is open and the magazine and/or chamber are free of any ammunition or brass.
8. Be sure that the ammunition you are using is factory loaded, is of the correct caliber for the firearm in which it is to be used, and that it is not damaged in any way.
9. Before firing, remove the magazine from the firearm, lock the bolt open, make sure the chamber is clear of any ammunition or brass, and check the barrel of the unloaded firearm for any possible obstructions.
10. Before firing any firearm that is unfamiliar to you, make sure that you understand exactly how it functions. A lack of familiarity with the firearm can result in serious accidents. Attend a certified training course on any firearm which you intend to use or with which you are not sufficiently familiar.
11. Always wear hearing and eye protection when using your firearm.
12. Keep all body parts, particularly the hands and fingers, away from the muzzle to avoid injury or burns.
13. Be sure that parts of the hand do not touch or interfere with the action.
14. Firearms should be stored separately from ammunition and beyond the reach of children, and/or any untrained individuals.
15. Avoid the use of any alcoholic beverages or drugs before and during the use of any firearm.
16. Discharging firearms in poorly ventilated areas, cleaning firearms, or handling ammunition may result in exposure to lead, a substance known to be associated with birth defects, reproductive harm, and other serious injury. Have adequate ventilation at all times. Wash hands thoroughly after exposure.
17. To make the firearm safe, one must ensure the chambered round is removed during the clearing procedure. Removal of the rifle's magazine does not remove the chambered round. This can only be done with the rearward movement of the bolt after the magazine is removed.

**STOP! KNOW HOW TO CLEAR THIS FIREARM BEFORE ATTEMPTING TO OPERATE. SEE PAGE 5**

# MR762A1

## OPERATOR'S MANUAL



### Covering the MR762A1 7.62 x 51 mm Rifle

---

**WARNING: A firearm has the capability of taking your life or the life of someone else! Be extremely careful with your firearm. An accident can occur at anytime and is almost always the result of not following basic safety rules.**

---



**HECKLER & KOCH**

© Heckler & Koch, 1/2012, revised (electronic edition) 6/2012  
All rights reserved  
Heckler & Koch  
5675 Transport Boulevard  
Columbus, Georgia 31907  
Tel: (706) 568-1906 • Fax: (706) 568-9151

Global Website: [www.heckler-koch.com](http://www.heckler-koch.com) • American Website: [www.hk-usa.com](http://www.hk-usa.com)

Every attempt has been made to ensure the accuracy of this information, however errors or changes may occur. Imagery used depicts a variety of MR762A1 models (some shown with accessories) and does not reflect the actual sales configuration.  
Specifications and models subject to change without notice.

## TABLE OF CONTENTS

	Safety Precautions.....	Inside Cover
	Clearing.....	5
Section 1	Introduction.....	6
Section 2	Nomenclature and Description.....	7
Section 3	Function and Operation.....	12
Section 4	Sights, Sight Adjustment and Aiming.....	15
Section 5	Ammunition.....	17
Section 6	Instructions for Use.....	18
	Loading the Magazine.....	18
	Loading the Rifle.....	18
	Firing the Rifle.....	20
	Unloading the Rifle.....	21
Section 7	Disassembly and Assembly.....	22
	Disassembly of the MR762A1.....	22
	Assembly of the MR762A1.....	28
	Function Check.....	35
	Magazine Disassembly.....	36
	Magazine Assembly.....	38
Section 8	Cleaning and Maintenance.....	40
	Lubrication.....	41
Section 9	Troubleshooting Problems and Repair.....	44
Section 10	Exploded Diagram and Parts List.....	46
Section 11	Specifications.....	49
	Warranty Registration.....	49
	Firearms Service Record.....	50

## CLEARING THE MR762A1



1. ON SAFE — Point the muzzle in a safe direction with the finger off the trigger and outside the trigger guard. Place the selector on "SAFE. The safe position is indicated by a closed white box containing a bullet symbol with an "X" over it."

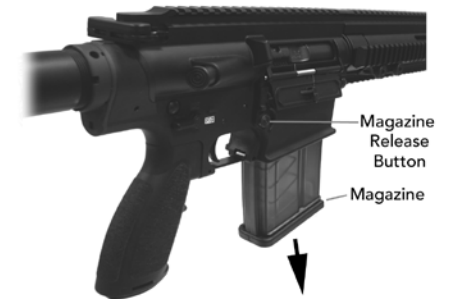

2. REMOVE MAGAZINE — Remove the magazine (if applicable) by depressing the magazine release button located on the right hand side of the lower receiver.



3. RETRACT BOLT — Depress the catch located on the charging handle and rack the bolt to the rear two or three times in quick succession to extract and eject any cartridges that may have been loaded into the barrel.

4. LOCK BOLT TO THE REAR — Lock the bolt to the rear by pulling the charging handle all the way back. Once the bolt reaches its limit of rearward travel, depress the bottom of the bolt catch located on the left hand side of the lower receiver.



5. INSPECT THE CHAMBER — Perform a visual inspection of the chamber area to ensure that no live rounds are present in the rifle prior to disassembly.



6. RETURN THE BOLT TO BATTERY — Depress the grooved paddle (top portion) of the bolt catch or by slightly pulling back on the charging handle until the bolt catch disengages from the bolt, allow the action spring to move the bolt all the way forward.

## SECTION 1 — INTRODUCTION

The thirty caliber (7.62 x 51 mm) counterpart of the 5.56 mm MR556A1, the MR762A1 also traces its lineage to the select fire HK416/HK417 model line. The MR762A1 is a semi-automatic rifle developed by Heckler & Koch as a premium level commercial/civilian firearm with match rifle capability. Like the entire line of HK416/HK417/MR556A1 long guns, the MR762A1 is a major product improvement over conventional AR-type carbines and rifles. The MR762A1 uses the HK proprietary gas piston operating system, employing a piston and a solid operating "pusher" rod in place of the gas tube normally found in many AR15/M16/M4/AR10-type firearms.

This method of operation virtually eliminates malfunctions that are common to direct impingement gas systems since hot carbon fouling and waste gases do not enter the receiver area. This is the same key feature critical to the success of the HK416 and HK417 rifles used by leading military and law enforcement customers. The MR762A1 is assembled in the USA using American and German made components. The MR762A1 uses many of the same assemblies and accessories developed for the HK417 including the HK free-floating four-quadrant rail system.

The HK Free Floating Rail System (FFRS) handguard has four MIL-STD-1913 Picatinny rails and allows all current accessories, sights, lights, and aimers used on AR-type arms to be fitted to the MR Series. The HK rail system can be installed and removed with simple tools and returns to zero when reinstalled. The MR762A1 also has a Picatinny rail machined into the top of its upper receiver for mounting optics and mechanical sights.

Like the selective-fire HK417, the MR762A1 uses a German-made barrel produced by Heckler & Koch's famous cold hammer forging process. The highest quality steel is used in this unique manufacturing process producing a barrel that provides superior accuracy and long service life. But unlike the HK417, the MR762A1 does not use a chrome-lined barrel. Chrome-lining can sometimes mask bore imperfections and negatively affect accuracy. For the new series of Heckler & Koch semi-automatic MR rifles, HK designers and engineers believe best accuracy comes with an unlined bore.

Used with the HK Free Floating Rail System, the barrel does not touch the handguard, ensuring the barrel is truly free-floating for maximum accuracy. The unchromed barrel has an internal profile of 4 lands and grooves with a 1 in 11 inch (280 mm) twist. It is also moderately "swagged" with a slightly smaller internal diameter at the muzzle end than the chamber end. This feature has a positive effect on bullet accuracy and velocity. The thick, heavy contour 16.5 inch MR762A1 barrel also contributes to its excellent accuracy.

A precise enhanced two-stage trigger adds significantly to the accuracy of the MR762A1 and an extended latch charging handle makes operating the rifle with a telescopic sight easier. The retractable buttstock can be locked into a solid, non-moving position by tightening an Allen screw in the bottom of the stock. Special target rifle takedown pins ensure the upper and lower receivers are firmly mated for accurate performance.

Designed to function with a wide variety of high quality 7.62 x 51 mm ammunition, the MR762A1 uses a C.I.P. dimensioned chamber (a chamber with dimensions specified by the Commission Internationale Permanente). The MR762A1 also functions reliably with most quality Caliber .308 Winchester ammunition. The MR762A1 is being produced with the same commitment to quality as German-made HK firearms. By using joint U.S./German manufacturing, Heckler & Koch leverages the relative strengths of two continents to make the preeminent semi-automatic 7.62 mm/caliber .308 type firearm, combining the design innovations of the USA and Germany into one new product.

## SECTION 2 — NOMENCLATURE & DESCRIPTION

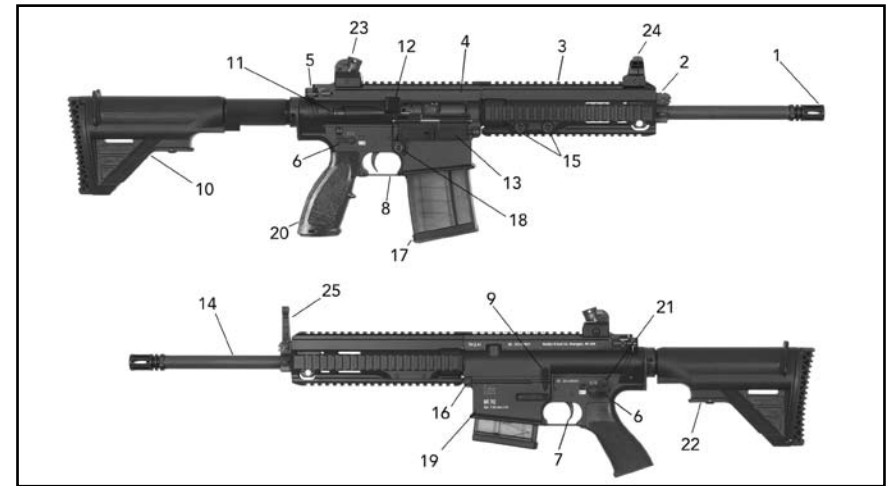

Fig. 1 – MR762A1 Right and Left Views

1. Compensator – Bird cage style flash hider is screwed to the end of the barrel and helps compensate for muzzle rise during firing.
2. Gas Block – Directs the expended gas from the gas port hole in the barrel and pushes the piston rearward, pushing the piston rod and bolt carrier rearward (defined in more detail in the cycle of operation). Contains an attachment point for the optional HK folding front sight.
3. Free Floating Rail System (FFRS) – The HK FFRS is a free-floating detachable rail system with four-quadrant MIL-STD-1913 (Picatinny) rails that can mount a variety of accessories including sights, scopes, a forward grip, lights, laser aimers, bipods, and sling hardware. The bore sight alignment of aiming devices is repeatable (no re-zeroing required) when the Free Floating Rail System is removed and reinstalled on the firearm. The Free Floating Rail System is removed and reinstalled with a 5 mm Allen wrench.
4. Upper Receiver – The upper receiver is a flat-top design with an integral MIL-STD-1913 (Picatinny) rail that provides support for the barrel, FFRS, gas system, and bolt carrier assembly. It has a case deflector and ejection port. It connects to the barrel and barrel socket. The piston rod is guided through the upper receiver by a bushing and activates the bolt carrier. The charging handle is a part of the upper receiver as is the forward assist and ejection port cover. The upper receiver is made from an aluminum forging.
5. Charging Handle – Allows the operator to chamber or clear a round and cock the firearm. It also provides for initial charging of the firearm. The charging handle is locked in the forward position during firing to prevent injury to the operator. An enhanced charging handle with an extended catch is available on the MR762A1.
6. Selector/Safety Lever – Allows the operator to select the mode of fire and place the firearm on safe. The selector lever is manually activated and unlike competing AR systems, can be switched to safe even if the hammer is not cocked.

7. Trigger – When activated by the operator, initiates the firing sequence. Located inside the lower receiver, the trigger when squeezed with the firearm loaded and off “safe” will fire the gun, “SEMI-AUTOMATIC” will fire one round each time the trigger is pulled. The MR762A1 uses a proprietary HK two-stage trigger for optimal accuracy.

8. Trigger Guard – The trigger guard protects the trigger. It can be lowered by depressing the detent with a pointed implement, allowing the use of heavy gloves or mittens to be used to fire the rifle.

9. Bolt Catch/Bolt Release – The bolt catch/release is manually operated. When the bolt carrier is pulled fully to the rear, the bottom of the bolt catch/release is pressed by the operator and then the bolt will be captured. To release the bolt, simply press the top of the bolt catch/release. The bolt catch/release is also automatically activated when firing the last round in a magazine.

10. Sliding Buttstock – Attached to the firearm via the receiver extension. The sliding buttstock is ambidextrous and adjustable to 5 positions for length of pull by pressing in on the rear portion of the release lever. It also contains the rear sling attachment points. Many optional buttstocks can be attached to the MR762A1 as long as they fit on the Receiver Extension (Buffer Tube), which has MIL-SPEC cross sectional dimensions.

11. Forward Assist – Ensures that the bolt is fully closed and locked. The forward assist is used when a round is not fully chambered. You can push on the forward assist until the bolt seats the cartridge fully into the chamber. It will return to its rearward position by spring pressure. It can also be used to silently load the firearm.

12. Case Deflector – Built into the upper receiver, deflects the cartridge cases away from the operator.

13. Ejection Port Cover Assembly – The ejection port cover is attached to the upper receiver and is spring loaded. It will open automatically if the charging handle is pulled to the rear or if the firearm is fired and can be manually closed at any time. It closes over the ejection port to prevent sand, dust, etc. from entering the chamber. It should remain closed when the firearm is not being fired.

14. Barrel Assembly – The chamber accepts the cartridge for firing and directs the projectiles down range. The barrel is cold hammer forged and has standard land and groove rifling with a 1 in 11 inch (280 mm) twist. The barrel is pressed into the upper receiver assembly and held in place by the threaded barrel nut.

15. Locking Screws, Free Floating Rail System (FFRS) – The Free Floating Rail System is fastened with two locking screws to the forward extending barrel locking bushing. Fastening and positioning of the Free Floating Rail System on the bushing is positive and ensures maintenance of zeroing on any sight system which has previously been attached to the rail after removal and remounting of the rail. The Locking Screws are captive and should not be completely removed, they can be tightened and loosened by using a 5 mm Allen wrench.

16. Pivot Pin – The pivot pin allows the upper receiver to pivot when the rear takedown pin is depressed. When both the pivot pin and rear takedown pin are depressed, the upper and lower receiver groups can be separated. The pivot pin is captive and should not be removed. Both the pivot pin (front takedown) and rear takedown pin have locking shafts that need to be pressed while the pins are depressed and engaged.

---

**NOTE: Both the pivot pin and the rear takedown pin are special precision “target rifle” pins. For disassembly and reassembly, a center detent in the shaft of the pin must be engaged under pressure and held to move the pins back and forth. DO NOT FORCE THE PINS. Forcing the pins could damage the rifle and such damage is not covered under the HK warranty. Contact HK Customer Service with any questions, TEL: 706-568-1906, EMAIL: cs@heckler-koch-us.com.**

---

17. Magazine – Holds cartridges ready for feeding and provides a guide for positioning cartridges for stripping and chambering. The magazine provides reload capabilities for sustained firing. The HK 10-round polymer magazine and optional 20-round magazine have a specially shaped follower that will not cant during the feeding process. The spring is stronger and more reliable than standard magazine springs.

18. Magazine Catch/Magazine Release – Holds the magazine (in place) in the magazine well and allows the operator to release the magazine and remove it from the firearm. The magazine catch is activated automatically when the magazine is properly inserted into the magazine well. The magazine catch is spring loaded and when the button is depressed, the magazine will drop free from the firearm when this control is activated.

19. Lower Receiver – Contains the fire control system for the firearm. The lower receiver contains the hammer, trigger, disconnect, sear, magazine well, magazine catch/release, bolt catch/release, selector/safety lever, buttstock assembly with buffer and recoil spring, pistol grip and trigger guard. The lower receiver is made from an aluminum forging and provides a beveled magazine well to ease reloading.

20. Pistol Grip – The pistol grip is made so it can be used by a left or right handed shooter. It has a trapdoor on the bottom so extra batteries, small tools, or other accessories may be stored. Other AR-type pistol grips can also be installed.

21. Rear Takedown Pin – When the rear takedown pin is depressed, it allows the upper receiver to pivot on the front pivot pin. This pin is captive and should not be removed. Like the pivot pin (front takedown pin), the rear takedown pin has a locking shaft that needs to be pressed while the pins are depressed and engaged for disassembly and reassembly.

22. Buttstock Release Lever – The buttstock release lever locks the telescopic buttstock to the tubular rear buttstock extension. The buttstock is adjustable in length in 5 positions.

23. Rear (Diopter) Sight – proprietary HK sight used on many HK firearms, attaches to the MIL-STD-1913 top rail of the upper receiver. Optional accessory.

24. Front Sight – proprietary HK sight used on many HK firearms, attaches to the MIL-STD-1913 top rail of the Free Floating Rail System (FFRS). Optional accessory.

25. Front (Flip up) Sight – proprietary HK sight attaches to the gas block, folds down when not in use. Optional accessory.

#### **INTERNAL PARTS NOMENCLATURE**

Muzzle – The muzzle is the area at the end of the barrel and the last area that the projectile touches before it exits the bore.

Bore – The part of the barrel that the projectile travels through from the chamber to the muzzle and contains lands and grooves which make the projectile rotate.

Chamber – The chamber is the area where the cartridge is seated and the initial phase of firing occurs.

Bolt and Carrier Assembly – Provides stripping, chambering, locking, firing, extraction, and ejection of the cartridges using the recoil spring and projectile propellant gases for power. These parts are made of the highest quality steel.

Bolt – The bolt locking lugs rotate and lock the barrel and bolt together prior to cartridge ignition.

Extractor – The extractor grabs the rim of the cartridge case and pulls the case out of the chamber. The extractor spring and buffer provide constant pressure on the rim until the case is ejected.

Ejector – The ejector pushes against the cartridge base under constant spring tension and once the cartridge or case is extracted and clears the front of the ejection port, the cartridge or case is ejected from the firearm.

Cam Pin – The cam pin allows the bolt to cam inside the bolt carrier, which allows the bolt to lock into the barrel extension when fully forward and cams to unlock when the carrier is pulled to the rear.

Firing Pin – The firing pin will strike the primer and initiate the firing sequence once the trigger is pulled. The firing pin will only protrude through the face of the bolt when the bolt is fully locked forward.

Drop Safety/Firing Pin Safety – Prevents an accidental discharge in the event of dropping or jolting the gun.

Firing Pin Retaining Pin – Retains the firing pin in the bolt carrier.

Recoil spring and buffer – The recoil spring provides constant pressure on the bolt carrier and holds the bolt in a locked forward position. The buffer has tungsten granules that act as an anti-bounce back mechanism.

Buffer detent – Captures the buffer and spring and when depressed, releases them for removal.

Hammer – The hammer, when released by the trigger, strikes the firing pin. The hammer returns when the bolt carrier pushes back under recoil, the hammer makes contact with the disconnecter and will release from the disconnecter when the trigger is released. The hammer remains cocked under spring pressure.

Trigger – The trigger, when squeezed, releases the hammer and returns under spring tension.

Disconnecter – Captures the hammer when it is cocked to the rear and releases the hammer to the sear when the trigger is released. The disconnecter then returns to its original position under spring tension.

## ASSEMBLY GROUPS

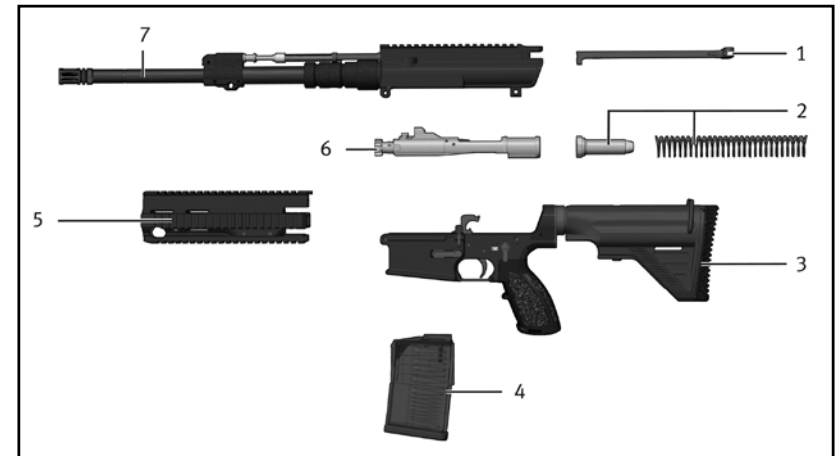

Fig. 2 – MR762A1 Major Assembly Groups

1. Charging Handle Assembly
2. Buffer and Recoil Spring
3. Lower Receiver Assembly - contains the buttstock assembly (holds buffer and recoil spring), pistol grip, selector lever, trigger group, trigger guard, magazine catch/release, bolt catch/release, magazine well, pivot pin and take down pin.
4. Magazine Assembly (20-round shown)
5. Handguard - Free Floating Rail System
6. Bolt Carrier Assembly
7. Upper Receiver Assembly - contains the forward assist, case deflector, ejection port cover assembly, gas block, compensator, barrel, gas piston and piston rod.

## SECTION 3 — FUNCTION AND OPERATION

The function and operation of the MR762A1 is similar to that found in semi-automatic firearms and consists of eight steps: (1) Feeding, (2) Chambering, (3) Locking, (4) Firing, (5) Unlocking, (6) Extracting, (7) Ejecting, and (8) Cocking.

These eight steps are explained below with a brief description of what occurs inside the rifle during each step. Assume that a full magazine is loaded in the rifle with the magazine follower spring forcing the follower and thus the top cartridge into the path of the bolt and the bolt is locked to the rear.

(1) Feeding. The bolt is released from the bolt catch, either by deploying and then releasing the charging handle or by depressing the bolt catch. The bolt assembly moves forward, being driven by the expansion of the recoil spring. The bottom locking lugs on the bolt head act as a feed pawl, striking the top cartridge of the magazine and moving the cartridge towards the chamber in the rear of the barrel.

(2) Chambering. The recoil spring continues to drive the bolt assembly forward until the bolt head seats the cartridge into the barrel's chamber. Chambering is complete when the extractor snaps into the extracting groove on the cartridge and the ejector is forced into the face of the bolt.

(3) Locking. Locking occurs when the bolt reaches its limit of forward travel. When the bolt is moving forward, the cam pin orients the bolt head by ensuring that the locking lugs on the bolt head will pass between the gaps of the locking lugs located on the barrel extension (chamber). The bolt then strikes the back of the barrel and then stops. The action spring continues to move the bolt head carrier forward, thus causing the cam pin to pivot on the bolt head's raceway. This action pivots the bolt head and rotates the bolt head's locking lugs counter-clockwise until they engage the locking lugs on the barrel extension. The bolt assembly is now locked into the upper receiver.

(4) Firing. Firing occurs when the firing pin strikes the primer in the head of the cartridge. When the trigger is pulled, the trigger's sear surface disengages from the hammer's intercept notch and the hammer releases. The hammer moves forward under pressure from the hammer spring, disengaging the drop safety, striking the firing pin, and overcoming the inertia of the firing pin spring. This drives the firing pin against the primer, which in turn ignites the propellant in the cartridge case and propels the bullet through the barrel.

(5) Unlocking. Unlocking occurs after a cartridge is fired. As the bullet is forced through the barrel by expanding gases, a small amount of gas enters through the gas port into the gas block. The gas block features a small expansion chamber that quickly fills up with gas. The gas then hits the front of the gas piston, causing the three piston rings to expand, and driving the gas piston rearwards. Because the pusher rod is mounted in the gas piston, the pusher rod moves back as well. The back of the pusher rod hits the anvil (string surface) on top of the bolt head carrier, causing the bolt head carrier to move rearwards. As the bolt carrier assembly moves rearward, the bolt cam pin rotates and unlocks the bolt from the locking lug recesses in the barrel extension. The unlocked bolt is now ready to move rearward. Any remaining gas follows the bullet out of the muzzle.

(6) Extracting. Extracting removes the empty cartridge case from the chamber. As the bolt unlocks, the bolt rotates slightly counterclockwise, causing the extractor to rotate the cartridge case within the chamber. The expanded case breaks contact with the chamber walls, allowing extraction to occur.

(7) Ejecting. Ejecting throws the empty cartridge case out of the receiver. As soon as the bolt has drawn the cartridge case clear of the chamber, the force of the ejector spring and plunger pushes the cartridge case head away from the bolt face. This causes the forward end of the cartridge case to move outward to the right. A deflector on the outside of the upper receiver deflects the cartridge case away from operator.

(8) Cocking. Cocking occurs when the hammer is forced into position for firing the next cartridge. This happens as the bolt carrier assembly travels toward the rear. The bolt carrier assembly forces the hammer back and rides over it. The hammer is caught by the disconnecter if the trigger is still held to the rear and by the trigger's sear surface if the trigger has been released.

### SELECTOR/SAFETY LEVER FUNCTION

---

**NOTE: The MR762A1 has ambidextrous selector/safety levers, that is safety levers located on both sides of the lower receiver. Either lever can be manipulated and moves the lever on the other side. Unlike many AR-style firearms, the selector/safety levers of the MR762A1 can be placed on the "SAFE" position even if the MR762A1 is not cocked.**

---

"SAFE POSITION" – Place the selector lever with the point facing towards the closed white box containing a bullet symbol with an "X" over it (towards the muzzle, Fig. 3).

"SEMI-AUTOMATIC POSITION" – Place the selector lever with the point towards the closed red box containing a red bullet symbol in it (straight up position) (Fig. 4).



Fig. 3 – SAFE



Fig. 4 – SEMI-AUTO

## SECTION 4 — SIGHTS, SIGHT ADJUSTMENT, AND AIMING

MR762A1 rifles can accommodate a wide variety of optical and mechanical (iron) sights. For models with HK Diopter rotary sight sets, the sights are installed on the MIL-STD-1913 (Picatinny) rail with a Phillips #2 screwdriver or the HK sight tool (Fig. 5 & 6). Do not over tighten the screws.

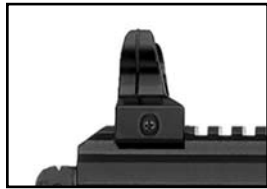

Fig. 5 – Front Diopter Sight



Fig. 6 – Rear Diopter Sight

For optimal sight use and the longest sight radius, the front sight is installed on the most forward portion of the MIL-STD-1913 rail and the rear sight is installed on the most rearward portion of the MIL-STD-1913 rail (located on the upper receiver). Sight adjustment is as follows:

1. Place target 100 meters (109.3 yards) downrange
2. Rotate rear drum until the 100 meter setting ("1") is visible to the shooter
3. Utilizing the HK sight adjustment tool and the acronym LLC (Low Left Clockwise); adjust the strike of the round until point of aim (POA) equals point of impact (POI).

Any corrections which may be required when sighting-in the weapon may only be performed by adjusting the rear sight for elevation or windage. MR rifles are designed to be sighted in at a range of 100 meters.

### ELEVATION ADJUSTMENT

Insert elevation adjustment tool into the rear sight cylinder so that the wedges of the tool engage in the two slots in the cylinder which contain the catch bolts. Press Phillips-head screwdriver downward into the adjustment tool and hold firmly. Rotate rear sight cylinder manually in the desired direction (Fig. 7). After correction withdraw Phillips-head screwdriver and remove elevation adjustment tool. The catch bolts will then re-engage in the slots. After performing the elevation adjustment set the desired aperture again.

**NOTE: Elevation: One 1/4 click of the drum will move the strike of the road approximately 1.5" (3.8cm) @ 100 meters. One 360 degree rotation of the drum will move the strike of the road approximately 6" (15.2cm) @ 100 meters.**

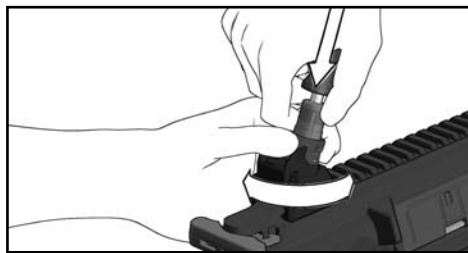

Fig. 7 – Rear Sight Adjustment

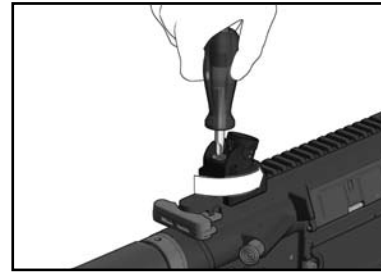

Fig. 8 – Clamping Screw  
(to tighten turn clockwise)

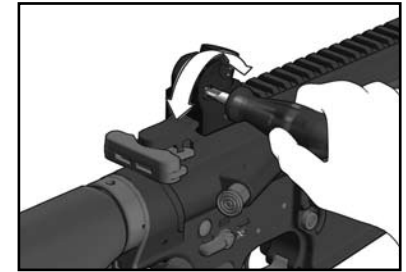

Fig. 9 – Windage Adjustment

### WINDAGE ADJUSTMENT

Point of impact, left: Loosen clamping screw on top of sight base (Fig. 8). Turn adjusting screw on the right side counterclockwise (Fig. 9) in accordance with the required correction. Then retighten clamping screw. This will move the impact to the Right. Point of impact, right: Loosen clamping screw (Fig. 8). Turn adjusting screw clockwise (Fig. 9) until the required correction has been performed. Then retighten clamping screw. This will move the impact to the Left.

**NOTE: Windage: One 360 degree rotation of the windage screw will move the strike of the road approximately 6" (15.2cm) @ 100 meters.**

### INSTALLING THE OPTIONAL FLIP-UP FRONT SIGHT

Press front sight onto front sight holder until the axes holes of front sight and front sight holder are aligned. Push through front sight axles all the way, from the right to the left and secure the front sight axles by snapping the retaining clip. Check function of foldable front sight (Fig. 10 & 11).

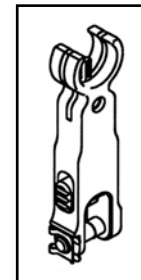

Fig. 10



Fig. 11



Fig. 12

A wide variety of mechanical, optical, telescopic sights and accessories can be installed directly on the upper MIL-STD-1913 rail (example, Fig. 12), either on the upper receiver portion of the rail or on the four quadrants of the Free Floating Rail System. For sight alignment and zeroing, follow the instructions of the scope manufacturers (Fig. 12).

**NOTE: Do not overtighten scopes, aimers, or any other accessories mounted on any of the MIL-STD-1913 (Picatinny) rail surfaces of the MR762A1. Overtightening can damage the rails.**



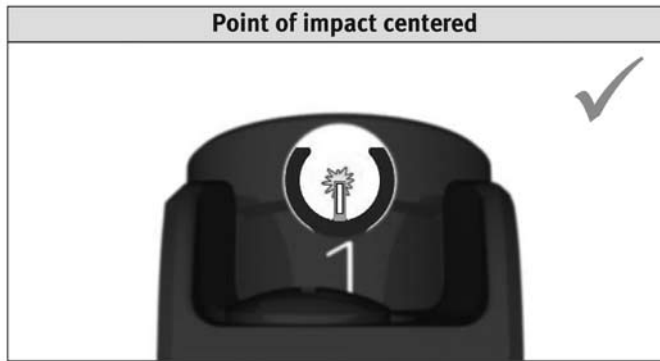

Fig. 13 – Correct Aiming

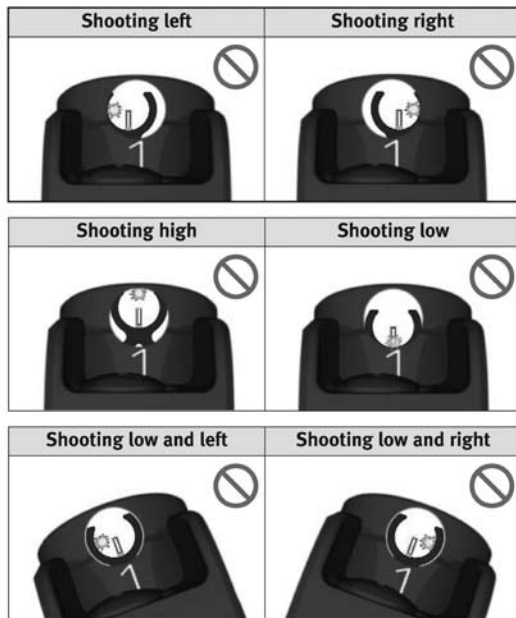

Fig. 14 – Aiming Errors

By using ammunition with match bullets or other match grade ammunition the MR762A1 will achieve the best level of accuracy. Use ammunition of the appropriate caliber and of recent manufacture. The MR762A1 is chambered for 7.62 x 51 mm ammunition and will functioned safely and reliably with most high quality 7.62 x 51 mm and Caliber .308 Winchester ammunition.

**NOTE: Use only high quality 7.62 x 51 mm NATO or Caliber .308 Winchester ammunition in the MR762A1 rifle. Damage caused by the use of improperly assembled or remanufactured ammunition may void the HK Warranty. Do not use ammunition assembled with corrosive components (primers, propellants, etc.).**

The MR762A1 is designed to use ammunition made to NATO or SAAMI specifications.

## DO NOT USE

- Reloads or remanufactured ammunition. Beware of military surplus, foreign or outdated ammunition.
- Non-jacketed or exposed lead ammunition.
- Corrosive ammunition (primer and/or propellant).
- Empty cases as "dummy" (inert) rounds, as damage may result. Use complete dummy rounds available for training purposes.
- Any ammunition that exceeds NATO or SAAMI (Sporting Arms and Ammunition Manufacturers' Institute) pressure limits.
- Cartridges that are not 7.62 x 51 mm or Caliber .308 Winchester.
- Seriously corroded ammunition.
- Dented Cartridges.
- Cartridges with loose bullets.
- Cartridges exposed to extreme heat above 135°F (57°C) until they have cooled.
- Use only authorized ammunition that is manufactured to NATO and SAAMI specs.
- Ammunition that is wet or dirty.

**WARNING: Only use ammunition designed to NATO and SAAMI specifications that is factory-loaded, undamaged, and of the correct caliber. The use of low powered cartridges could lead to functional stoppages (including bullets stuck in the barrel) and is not recommended.**

**LOADING A MAGAZINE**

Magazines may be loaded by hand, one round at a time, or quickly loaded using a magazine loader. Loading a magazine by hand is depicted below (Fig. 15).

**Filling the magazine**

1. Hold the magazine with one hand. Place the cartridges onto the follower between the magazine lips and push the cartridge, with your thumb, down underneath the lips and ensuring the projectile is facing the front of the magazine and that the cartridge rim is fully to the rear of the magazine.
2. Repeat this step until the magazine is filled with the appropriate number of cartridges (10 or less for a 10-round magazine and 20 or less for 20-round magazines). Do not overfill magazines.

**Single rounds**

Magazines may be loaded with one round at a time by inserting the cartridge case in while depressing the follower and seating the case in until the projectile clears the front of the magazine. Continue this each time until the magazine is full. During and when finished filling the magazine gently tap the back of the magazine against the palm of your hand to ensure the rounds are seated properly.

**CAUTION: Ensure cartridges, especially those to be loaded into the magazine, are free of sand, mud, moisture, frost, snow, ice, grease, or other foreign matter.**

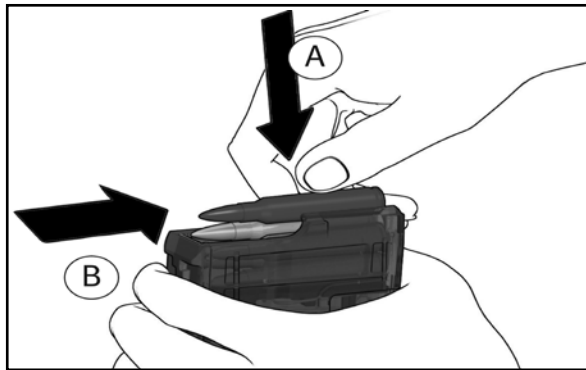

Fig. 15 – Loading Magazine

**WARNING: If the rifle is dropped or jarred with a loaded magazine in place and the bolt to the rear, it could chamber a round. Failure to follow this warning may cause injury or death.**

**Emptying the magazine**

Hold the magazine with one hand. Push the cartridges forward out of the magazine with the thumb of the other hand. Do not allow the cartridges to drop on a hard surface or they may become damaged. Do not unload cartridges using another cartridge, damage to the cartridge or injury to the operator may occur.

**NOTE: The magazine may be loaded into the weapon with the bolt assembly open or closed. The procedure listed below is for the bolt open.**

**LOADING**

Loading the MR762A1 rifle for firing

1. Place the selector lever in the SAFE position. Point the muzzle in a safe direction with the trigger finger off the trigger and outside the trigger guard.
2. Pull the charging handle rearward to open the bolt and lock it to the rear by pressing the bottom part of the bolt catch (Fig. 16).



Fig. 16

3. Check the chamber to ensure it is clear.
4. Insert a loaded magazine into the magazine well until the magazine catch engages the magazine (Fig. 17).
5. Tap upward on the magazine to ensure it is properly seated and tug slightly downwards on the magazine to verify it is properly engaged by the magazine catch.



Fig.17 – Inserting Magazine into the Rifle

6. Depress the upper portion (paddle) of the bolt catch. The bolt should go forward, stripping the top cartridge from the magazine and feeding it into the chamber (Fig. 18).



Fig. 18 – Depressing Bolt Catch to Chamber a Cartridge

7. Tap the forward assist to ensure the bolt is fully forward and locked (Fig. 19).



Fig. 19 – Tap Forward Assist

**WARNING: Always assume every weapon is loaded until it is verified through visual and physical inspection that it is not.**

Confirm the weapon is clear and on SAFE before performing the following procedures. Failure to follow these warnings may cause injury or death to personnel.

**CAUTION: Never ride the charging handle forward. Allow it to move forward under its own power.**

**NOTE: Close the ejection port cover if the weapon is not to be immediately fired.**

#### FIRING THE RIFLE

1. Place the selector lever on SEMI-AUTOMATIC.
2. Estimate range to target and adjust the rear sight by rotating the adjuster so that the desired range setting on the adjuster is aligned with the range index mark.
3. Sight in on the target and acquire proper sight picture and sight alignment.
4. Employing proper breathing techniques, fire the MR762A1 by slowly squeezing rearward on the trigger until the hammer releases from the sear.

**WARNING: Before firing the MR762A1, ensure that:**

1. The bore is clear of obstructions.
2. The firearm is pointed only at your intended target.
3. You are sure of your backstop and the impact area beyond.
4. Your hands and fingers are away from the muzzle.

#### RELOADING THE MR762A1

The magazine in the weapon is empty. The bolt is held to the rear by the bolt catch. Same procedure as above, except the bolt is already locked to the rear and you must first set the selector to "SAFE".

1. Set the selector lever to "SAFE".
2. Depress the magazine release button with the right index finger or thumb. Remove the empty magazine from the magazine well. Store the empty magazine in a magazine pouch.
3. Insert a loaded magazine into the magazine well until the magazine catch engages the magazine (Fig. 17).
4. Tap upward on the magazine to ensure it is properly seated and tug slightly on the magazine downwards to ensure the magazine is properly engaged by the magazine catch. Insert a loaded magazine into the magazine well until the magazine catch engages.
5. Push the bolt catch in to release the bolt and to chamber a round.
6. The weapon is now loaded and set on "SAFE."

#### UNLOADING THE MR762A1

Use the clearing procedures found on page 5 to unload (and clear) the rifle.

## SECTION 7 — DISASSEMBLY & ASSEMBLY

### DISASSEMBLY (FIELD STRIPPING) OF THE MR762A1

Tools Needed: MR762A1 Disassembly Tool (located in the Buttstock), 5mm Allen Wrench

1. Clear the MR762A1
  - a. Point the muzzle in a safe direction with the finger off the trigger and outside the trigger guard.
  - b. Place the selector lever on "SAFE"

**NOTE: The MR762A1 has ambidextrous selector lever/safety levers, that is safety levers located on both sides of the lower receiver. Either lever can be manipulated and moves the lever on the other side. Unlike many AR-style firearms, the selector lever/safety levers of the MR762A1 can be placed on the "SAFE" position even if the MR762A1 is not cocked.**

- c. Remove the magazine (if applicable) by depressing the magazine release button located on the right hand side of the lower receiver.
- d. Depress the catch located on the charging handle and rack the bolt to the rear two or three times in quick succession to extract and eject any cartridges that may have been loaded into the barrel.
- e. Lock the bolt to the rear by pulling the charging handle all the way back. Once the bolt reaches its limit of rearward travel, depress the bottom of the bolt catch located on the left hand side of the lower receiver.
- f. Perform a visual inspection of the chamber area to ensure that no live rounds are present in the MR762A1 prior to disassembly.
- g. Return the bolt to battery (all the way forward) by either depressing the grooved paddle (top portion) of the bolt catch or by slightly pulling back on the charging handle until the bolt catch disengages from the bolt and then allow the action spring to move the bolt forward.

**CAUTION: Never attempt to disassemble the MR762A1 with the bolt locked back to rear. After performing the clearance procedure, always ensure the bolt is forward before attempting to disassemble.**

2. Separating the Upper and Lower Receivers:
  - a. Rotate the recoil pad counter clockwise one quarter turn and separate the recoil pad from the buttstock. Remove the MR762A1 disassembly tool (Fig. 20, 21).

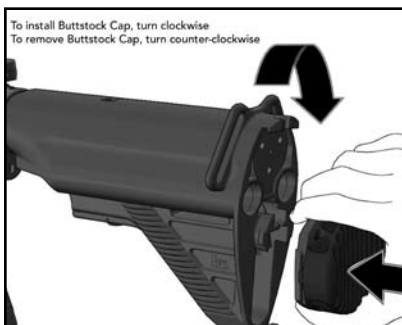

Fig. 20 – Removing the disassembly tool

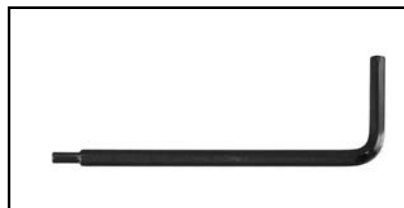

Fig. 21 – Disassembly tool

- b. Insert the small tip of the disassembly tool into the spring loaded detent located in the center of the rear takedown pin. Push the disassembly tool from left to right until the takedown pin reaches its limit of lateral travel (Fig. 22, 23).

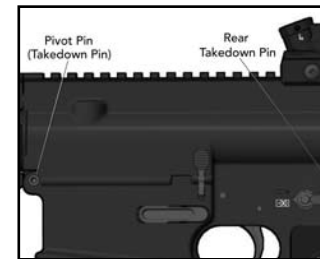

Fig. 22 – Takedown Pins

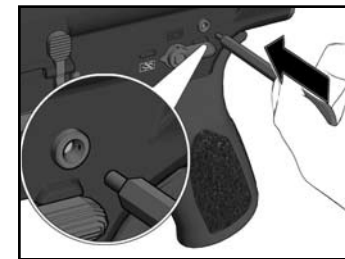

Fig. 23 – Takedown Pin Detail

**WARNING: Always use the disassembly tool to disengage the detents on both the rear takedown pin and the front pivot pin. Attempting to remove the pins without disengaging the detents could lead to damaging the lower receiver. Both the rear takedown pin and the front pivot pin are captive pins and will therefore remain attached to the lower receiver. Attempting to completely remove the takedown and pivot pins could lead to damaging the lower receiver.**

3. Bolt Assembly:

- a. Remove the upper receiver from the lower receiver (Fig. 24A), depress the catch on the charging handle and withdraw the bolt assembly from the rear (Fig. 24B). Continue to pull the charging handle to the rear until resistance is encountered. Lift up on the charging handle and separate the charging handle from the upper receiver.

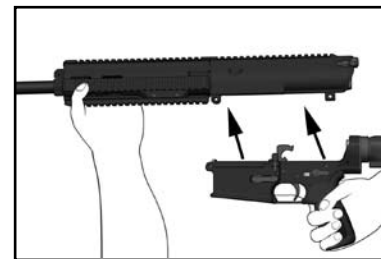

Fig. 24A – Removing the upper receiver

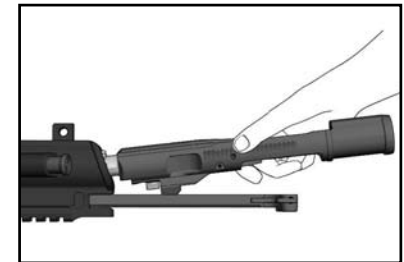

Fig. 24B – Removing Bolt & Charging Handle

- b. Insert the small tip of the disassembly tool into the right hand side of the firing pin retaining pin and drift the firing pin retaining pin from right to left until the firing pin retaining pin reaches its limit of lateral travel (Fig. 25).

**WARNING: The firing pin retaining pin is a captive pin and will therefore remain attached to the bolt carrier. Attempting to completely remove the firing pin retaining pin could lead to damage of the bolt assembly.**

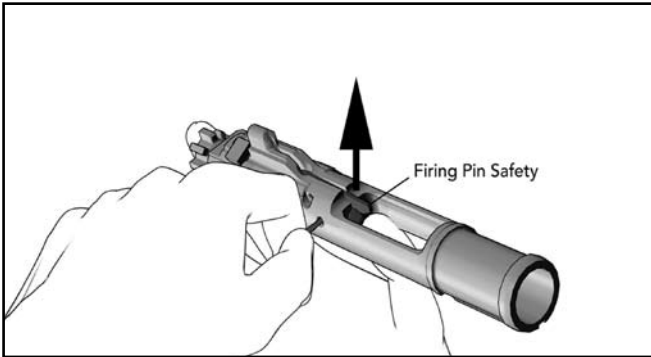

Fig. 25 – Drift out the Firing Pin Retaining Pin and lift up on the Drop Safety

d. Lift up on the spring-loaded drop safety (firing pin safety) and remove the firing pin and firing pin spring (Fig. 25 and Fig. 26).



Fig. 26 – Removing the Firing Pin and Firing Pin Spring from the Bolt Assembly

e. Lift up and remove the cam pin from the shaft of the bolt head (Fig. 27).

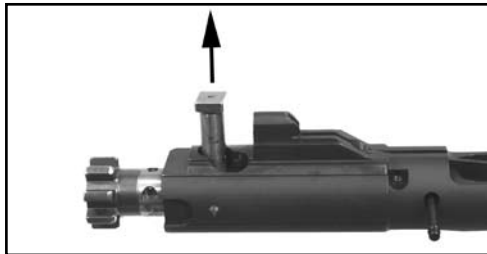

Fig. 27 – Remove the Cam Pin

f. Slide the bolt head from the front of the bolt carrier (Fig. 28).

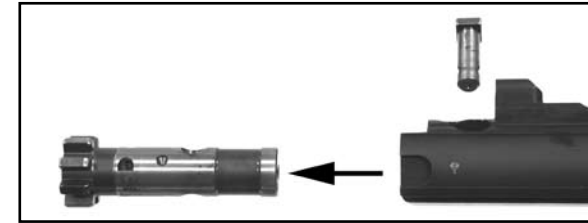

Fig. 28 – Slide the Bolt Head out

g. Further disassembly of the bolt head, including removal of the extractor is not recommended (Fig. 29).

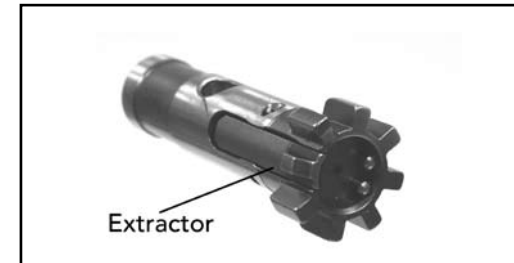

Fig. 29 – Bolt Head

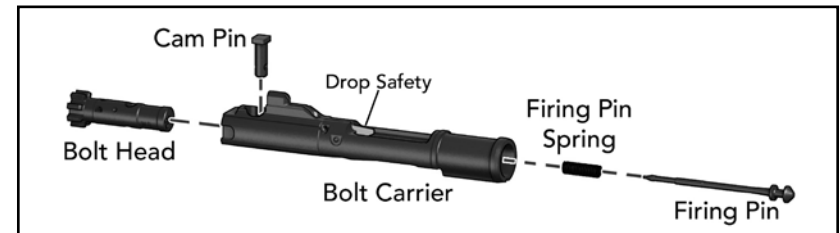

Fig. 30 – Bolt Assembly Components

**CAUTION: Removal of the MR762A1 extractor and the ejectors by the operator is not recommended.**

#### 4. Upper Receiver

- a. Insert a 5mm hex (Allen) wrench into the retaining screw located on the lower right hand side of the Free Floating Rail System (handguard) and rotate counter clockwise (Fig. 31). Once loosened, drift out the retaining screw from left to right until the retaining screw reaches its limit of lateral travel.

**WARNING: The retaining screws for the Free Floating Rail System (FFRS) handguard are held captive by small shaped springs located on the lower right hand side of the handguard. Attempting to completely remove the retaining screw could lead to damage of the handguard, shaped springs, and/or retaining screws.**

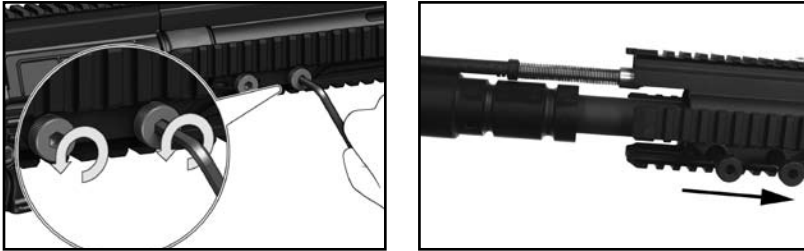

Fig. 31 – Loosening the FFRS screws with hex (Allen) wrench

- b. Slide the Free Floating Rail System (FFRS) off the barrel nut and remove the FFRS from the upper receiver.
- c. Grasp the rear of the gas piston while pushing back on the piston rod. Disengage the piston rod from the piston and slide out the piston rod from the upper receiver (Fig. 32).

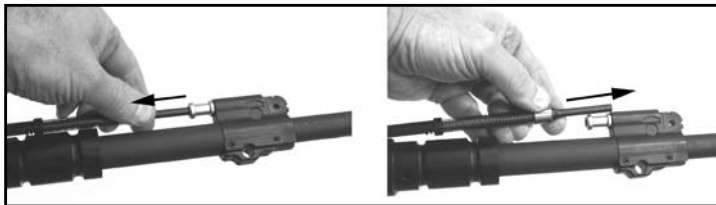

Fig. 32 – Removing Piston Rod

- d. Slide the gas piston to the rear and remove the gas piston from the gas block (Fig. 33).

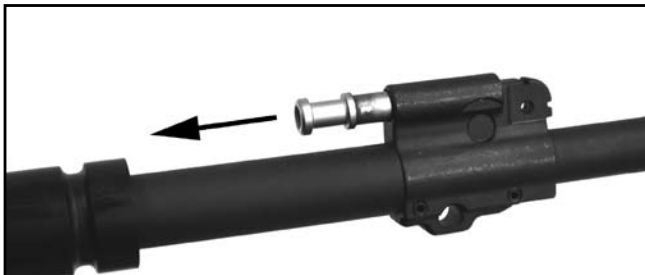

Fig. 33 – Removing Gas Piston

#### 5. Lower Receiver:

**NOTE: Always ensure the hammer is in the cocked position (down) before attempting to remove the buffer and action spring.**

- a. Depress the buffer detent with the tip of the piston rod and remove the buffer and action spring from the receiver extension (buffer tube) (Fig. 34).

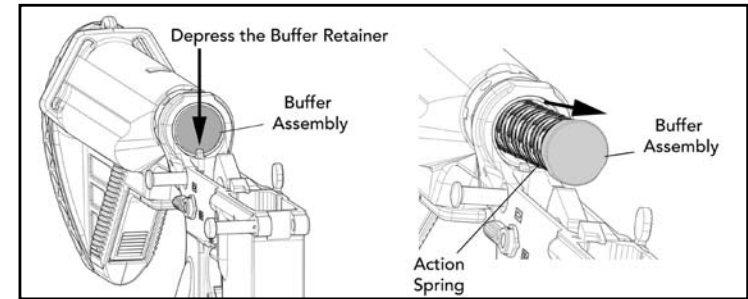

Fig. 34 – Removing Buffer Assembly

- b. Check to ensure that the buttstock tightening screw is loose before attempting to remove the buttstock. If tight, insert the large tip (3mm hex) of the MR762A1 Disassembly Tool into the tightening screw and rotate (but do not completely remove) counter clockwise (Fig. 35). For cleaning and general maintenance purposes, it is not necessary to remove the buttstock.



Fig. 35 – Buttstock Tightening Screw

- c. To remove the buttstock, simultaneously depress the back of the buttstock release lever while pulling downwards on the front lip. Slide the buttstock off the receiver extension.

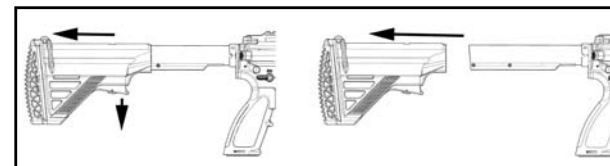

Fig. 36 – Removing Buttstock

The MR762A1 is now operator disassembled (field stripped).

**NOTE: Disassembly beyond the above field stripping procedures should only be undertaken by HK certified personnel.**

## REASSEMBLY (ASSEMBLY) OF THE MR762A1

Tools Needed: MR762A1 Disassembly Tool (located in the Buttstock), 5mm Allen Wrench, Small Straight Slot Screwdriver

### 1. Lower Receiver:

- a. Check to ensure that the buttstock tightening screw is loose before attempting to install the buttstock. If tight, insert the large tip (3mm hex) of the MR762A1 Disassembly Tool into the tightening screw and rotate (but do not completely remove) counter clockwise.
- b. Two small set screws are located on the bottom of the receiver extension (buffer tube). These set screws are provided to eliminate any play that may develop between the buttstock and the extension. The left hand side of the set screw features a detent surface that engages the buttstock. The right hand surface features a cut to accommodate a small straight slot screwdriver. Rotating the set screws clockwise will tighten the detents to the buttstock; rotating the setscrew counter clockwise will loosen the buttstock. Using a straight slot screwdriver, rotate the set screws clockwise using quarter turns and adjust until the detents engage the buttstock but do not hinder removal or installation (Fig. 37)

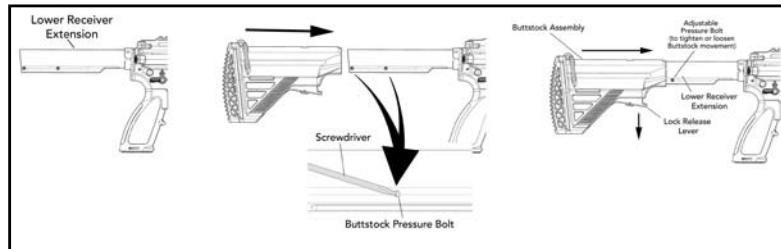

Fig. 37 – Buttstock reassembly

- c. Depress the back of the buttstock release lever allowing the front tab to pivot downwards. Pull down on the front tab until the locking pin is not visible inside the buttstock. Mount the buttstock onto the receiver extension. The buttstock is adjustable for length of pull, with five different settings available to the operator.

**WARNING: Ensure that only the proprietary HK buffer and recoil spring (action spring) are installed in the MR762A1. Use of non HK buffers and recoil springs could result in cycling problems and affect the reliability of the MR762A1 (Fig. 38).**



Fig. 38 – HK MR762A1 Proprietary Buffer

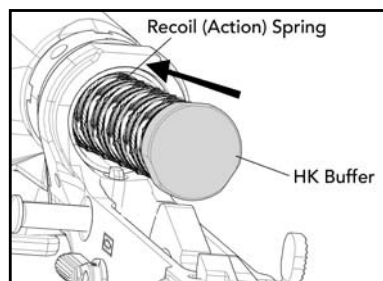

Fig. 39 – Installing buffer & action spring

- d. Ensure that the hammer is in the down (cocked) position before attempting to install the buffer and action spring. Mount the action spring onto the buffer and insert the buffer and spring into the receiver extension. Push back on the buffer far enough until the buffer is retained by the spring loaded buffer detent (Fig. 39).

### 2. Upper Receiver:

- a. Install the gas piston into the back of the gas block. The piston rings need not be staggered prior to installation (Fig. 40).

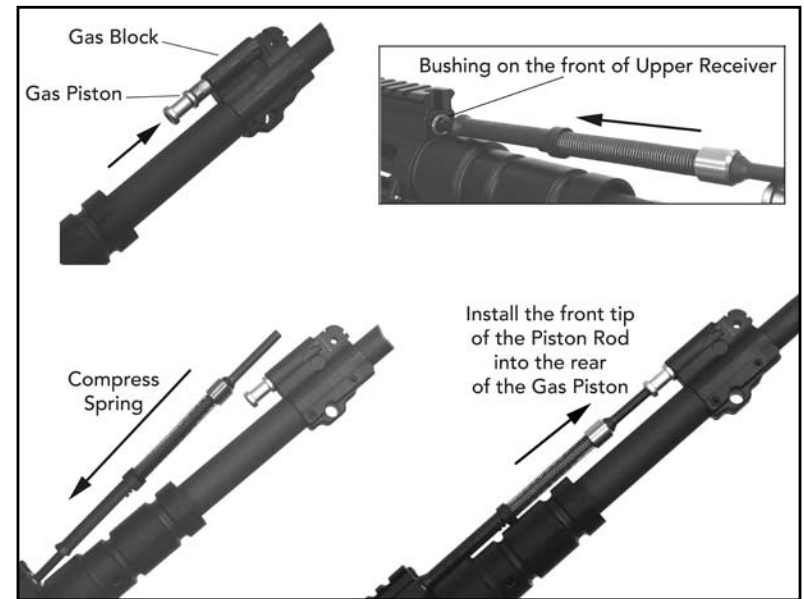

Fig. 40 – Reinstalling the Gas Piston and the Piston Rod

- b. Insert the rear of the piston rod into the bushing located at the front of the upper receiver above the barrel nut, compress the spring, and install the front tip of the piston rod into the rear of the gas piston.
- c. Slide the Free Floating Rail System (FFRS-handguard) onto the barrel nut, ensuring that the tongue on the FFRS mounts into the groove on top of the upper receiver. Once the FFRS is flush with the upper receiver, drift in the captive FFRS retaining screw. Insert a 5mm hex wrench into the retaining screws and rotate clockwise until hand tight.

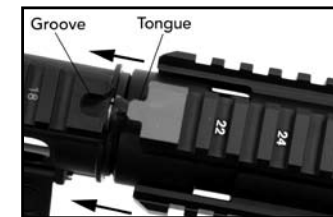

Fig. 41 – Reinstalling the FFRS handguard

3. Bolt Assembly:

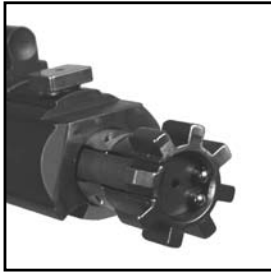

Fig. 42 – Bolt Assembly viewed from bolt face

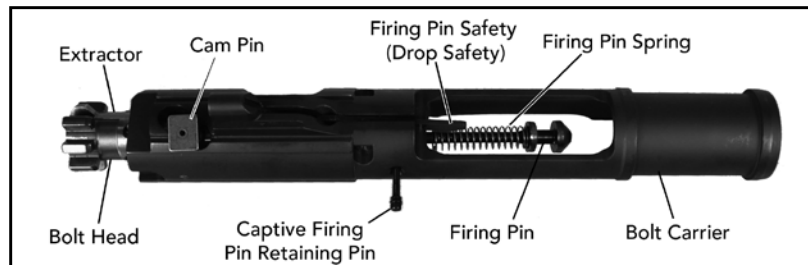

Fig. 43 – Bolt Assembly components

- a. Slide the bolt head into the bolt carrier until the circular mounting surface for the cam pin on the bolt heads aligns with the front of the raceway on the bolt head carrier. Pointed down range, the extractor should be on the right hand side of the bolt carrier and ejector should be on the left (Fig. 44).

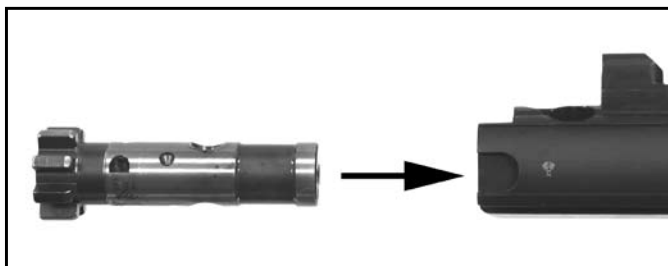

Fig. 44 – Bolt Carrier reassembly

**NOTE: The bolt head on the MR762A1 features a tapered mounting surface for the cam pin. This feature ensures that the bolt must be properly positioned in the bolt carrier before attempting to install the cam pin.**

- b. Insert the cam pin into the shaft of the bolt carrier, ensuring that the hole for the firing pin on the cam pin is aligned with the firing pin tunnels on both the bolt head and bolt carrier (Fig. 45).

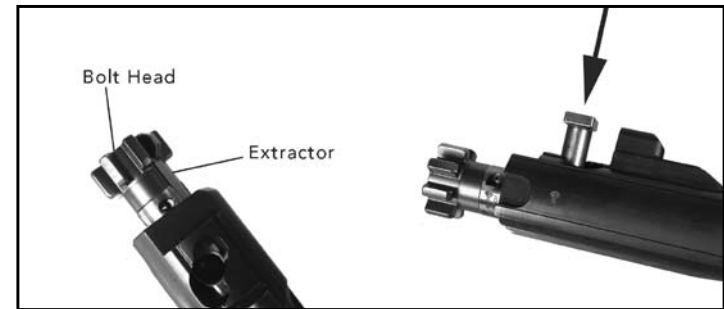

Fig. 45 – Bolt Carrier reassembly

- c. Ensure that the captive firing pin retaining pin is drifted completely out to the left hand side of the bolt carrier. Insert the firing pin spring onto the firing pin, pivot upwards on the spring loaded firing pin safety, and insert the firing pin and spring into the bolt carrier's firing pin tunnel until the firing pin reaches its limit of forward travel (Fig. 46).

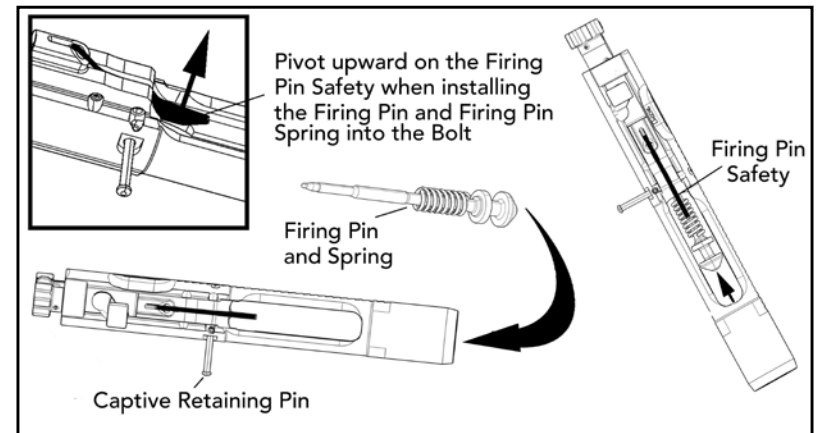

Fig. 46 – Installing the Firing Pin

- d. While maintaining forward pressure on the back of the firing pin, drift the firing pin retaining pin from left to right.
- e. Ensure that the firing pin retaining pin is properly installed by pivoting upwards on the firing pin safety while pushing backwards on the bolt head. The firing pin should be retained inside the bolt carrier (Fig. 47).



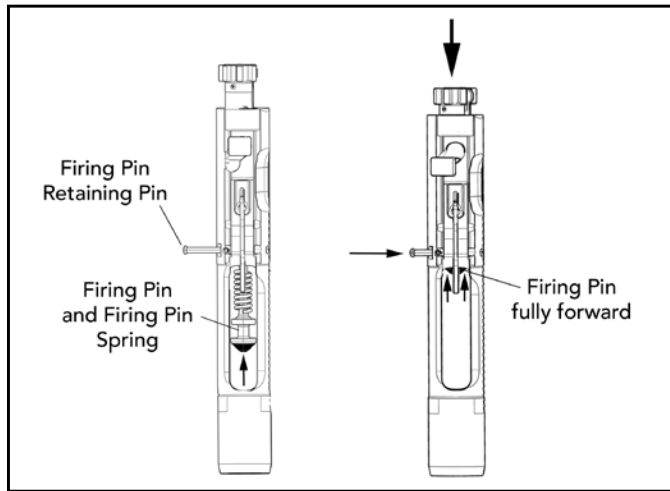

Fig. 47 – Firing Pin Retaining Pin Installation

- f. Turn the upper receiver upside down, insert the charging handle into the upper receiver, align the lugs on the outsides of the charging handle with the recesses on the inside of the upper receiver then press down until the charging handle is flush with the inside of the receiver then press slightly forward (Fig. 48).

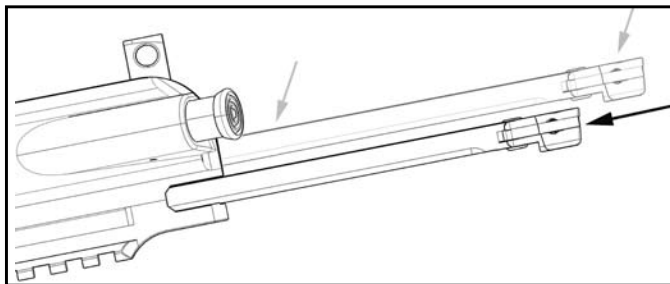

Fig. 48 – Charging Handle Installation

- g. With the upper receiver and charging handle upside down, install the bolt assembly onto the bottom of the charging handle ensuring that the bolt carrier's anvil and the top of the cam pin are centered in the bottom cavity of the charging handle (Fig. 49).

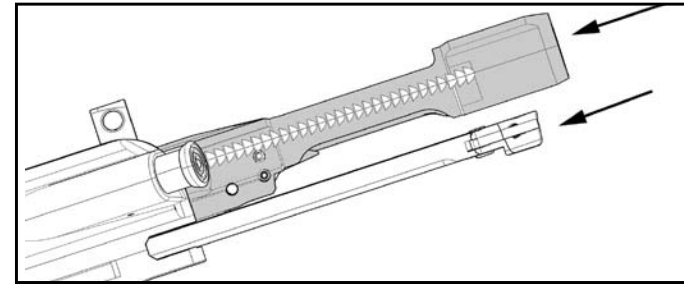

Fig. 49 – Installing the bolt assembly into the upper receiver

- h. Push the charging handle and bolt group completely into the upper receiver until the locking lugs on the bolt head engage the locking on the barrel extension and the latch on the charging handle engages the oval locking surfaces on either the left or right hand sides of the upper receiver (Fig. 50).

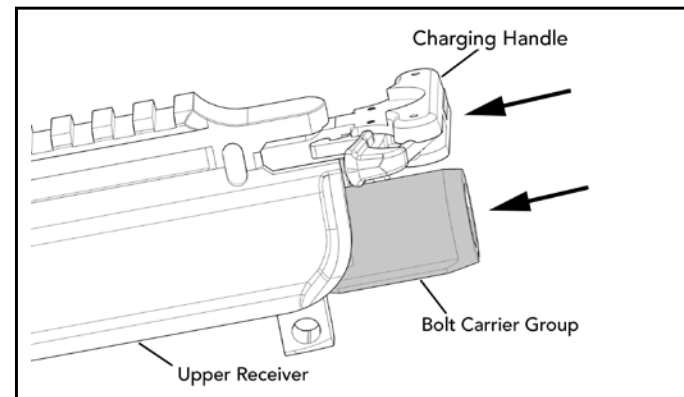

Fig. 50 – Completing installation of the bolt assembly into the upper receiver

#### 4. Upper and Lower Receivers:

**WARNING: Always use the Disassembly Tool to disengage the detents on both the rear takedown pin and the front pivot pin. Attempting to install the pins without disengaging the detents could lead to damage of the lower receiver.**

- Ensure that both the captive front pivot pin and rear takedown pin are drifted out to the right hand side of the receiver. If necessary, use the small surface of the MR762A1 disassembly tool.
- Place the upper receiver pointed downwards with the flash hider resting on a padded surface.
- Mount the lower receiver to the upper receiver. Drift the front pivot pin from right to left. The pivot pin will not completely lock but it will engage the upper receiver (Fig. 51).

- d. Insert the small tip of the disassembly tool into the spring loaded detent located in the center of the rear pivot pin. While pushing on the disassembly tool, drift the pivot pin from right to left until the pivot pin reaches its limit of lateral travel. The tip of the pivot pin should be visible on the left hand side of the lower receiver (Fig. 52).

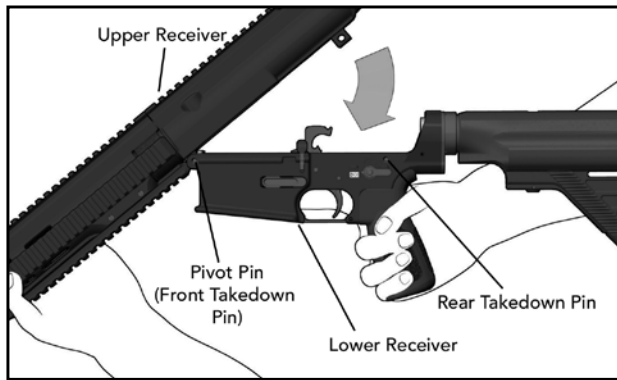

Fig. 51 – Closing Upper and Lower Receiver

- e. Insert the small tip of the disassembly tool into the spring loaded detent located in the center of the rear takedown pin. While pushing on the disassembly tool, drift the rear takedown pin from right to left until the rear takedown pin reaches its limit of lateral travel. The tip of the rear takedown pin should be visible on the left hand side of the lower receiver.

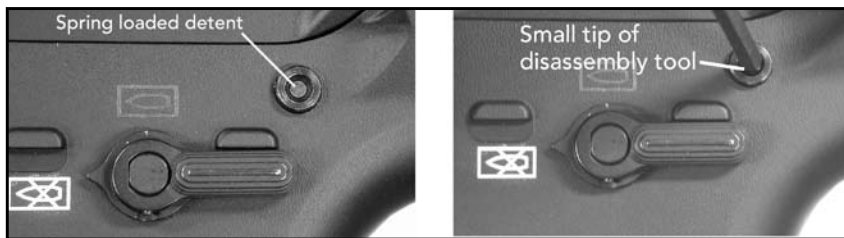

Fig. 52 – Detail of the rear Takedown Pin showing spring loaded detent.

- f. Install the disassembly tool into the storage channel located at the back of the buttstock.
- g. Mount the recoil pad onto the back of the buttstock with the recoil pad perpendicular to the buttstock. Ensure that the recoil pad is flush with the buttstock and rotate the recoil pad clockwise one quarter turn until the recoil pad engages the locking surfaces located on both the top and bottom of the buttstock.

## FUNCTION CHECK

**WARNING: Always ensure the MR762A1 is unloaded prior to attempting to perform a function check.**

**NOTE: The MR762A1's selector lever can be placed on safe regardless of the position of the hammer. Legacy AR15/M16 platforms and many of their large caliber counterparts (7.62 x 51 mm/.308 caliber) require that the hammer be cocked prior to attempting to place the firearm on "SAFE".**

## FUNCTION CHECK PROCEDURE

1. Perform clearing procedure (see above) and ensure selector lever is set on "Safe".
2. Place the muzzle in a safe direction and rack the bolt to the rear three or four times in quick succession by using the charging handle. The bolt should not bind when traveling back and forth in the receiver.
3. "SAFE": Let the bolt go forward and completely go into battery. With an unloaded MR762A1 and the muzzle in a safe direction, ensure the selector lever is set on "Safe" and attempt to pull the trigger. The hammer must not fall.
4. "SEMI-AUTOMATIC": Rotate the selector lever to "Semi-Automatic" (Single Shot) and with an unloaded MR762A1 and the muzzle in a safe direction, attempt to pull the trigger and hold to the rear. The hammer must fall.
5. While maintaining pressure on the trigger, rack the bolt and release. The hammer should be held by the disconnecter.
6. Release the trigger. The hammer should be caught by the sear as signified by a metallic click. Release the trigger completely and re-engage the trigger. Hammer must fall.
7. Insert an empty magazine into the magazine well and pull back on the charging handle. The magazine follower should engage the bolt catch and lock the bolt to the rear on an empty chamber.
8. Remove the magazine and allow the bolt to go into battery, either by depressing the bolt catch or by pulling the charging handle slightly back towards the rear and then releasing.
9. Ensure that the MR762A1 is unloaded, place the muzzle in a safe direction and pull the trigger to ease the tension on the trigger spring.
10. Place the selector lever back on "Safe" and snap the dust cover into position over the ejection port.

## MAGAZINE DISASSEMBLY

**CAUTION: Parts are under considerable spring pressure. Wear safety goggles and point the base of the magazine housing in a safe direction when disassembling or assembling. Read the complete procedure before attempting to disassemble the magazine.**

To disassemble the magazine for cleaning or inspection, push in the locking plate button (located in a hole in the magazine floorplate) with a finger, cleaning rod, cartridge, or similarly shaped object. As you depress the locking plate through the floorplate hole, push the floorplate towards the rear of the magazine housing (Fig. 53). Once the floorplate is clear of the magazine housing; the locking plate, spring, and magazine follower can easily be removed. Take note as to the arrangement of these parts for reassembly (Fig. 54). For cleaning purposes, it is not necessary to disassemble the follower and locking plate from the spring. Both 20 and 10-round magazines are disassembled and reassembled in the same matter.



Fig. 53 – Magazine Disassembly

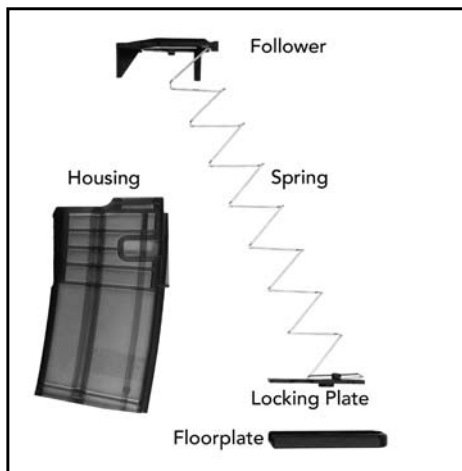

Fig. 54 – Magazine Components (20 round shown)

## ASSEMBLY (HK MAGAZINE)

To assemble the magazine, use the reverse sequence used for disassembly. If magazine was cleaned, ensure that it is properly lubricated prior to assembly. Attach the follower and locking plate to the spring and slide the follower into the magazine housing (it will only assemble in one direction, do not force it). Push the locking plate down into the housing enough so that the floorplate can be slid back onto the magazine housing. Ensure that the locking plate button is secure in the floorplate hole.

Check the function of the magazine by tapping it on your hand. Also check the function of the follower, for free movement by depressing it with the cleaning rod. Lastly check the secure attachment to and fit of the magazine in the rifle.

**CAUTION: It is possible to improperly load the cartridges if the guide is not positioned correctly, the rim of the cartridge could possibly get caught in the rear groove. Constantly check spring tension in between stripper clips. Unload magazine if in doubt. Replace the stripper clip guides regularly as they wear with use.**

Using thumb pressure on the rear of the top cartridge, press down firmly until all ten rounds are below the feed lips of the magazine. Remove the empty stripper clip while holding the stripper clip guide in place. Repeat until the magazine is full. Remove stripper clip guide and retain it for future use.

**NOTE: Do not slam the magazine on a table or a fixed hard surface during filling or damage to the feed lips may occur. Instead apply gradual pressure to accomplish this task.**

**NOTE: Protect the magazines from drop-induced damage on hard surfaces (concrete, metal, etc.). Many weapon stoppages begin in feed devices that are not properly cared for or that are abused unnecessarily.**

## SECTION 8 — CLEANING & MAINTENANCE

### CLEANING OF THE MR762A1

There are no special requirements, cleaners, or lubricants required for cleaning the MR762A1. The standard HK cleaning kit that is used for all 7.62 mm/.30 caliber rifles may be used for this firearm. Cleaning may be completed using dry cleaning solvent, bore cleaner, wiping with a cloth or an all purpose nylon brush. Using these guidelines will determine which applies. Cleaning materials are pipe cleaners, swabs, all purpose nylon brush and rags.

**NOTE: If cleaning is completed using a solvent, then a coat of lubricant must be applied for protection against rust and the elements. Dry cleaning solvent may be used to completely remove lubricants. For example, when using the rifle in extreme cold weather, dry cleaning solvent may be used to remove traces of CLP before applying LAW. The following lubricants (or their commercial equivalents) can be used: CLP (Breakfree, TW25 B), LSA, LAW, or OX24. Always shake CLP before use.**

CLP does three things at once:

1. It contains solvents to dissolve firing residue and carbon.
2. It lays down a layer of Teflon as it dries to provide lubrication.
3. It prevents rust from forming.

Use CLP as follows:

1. Always shake bottle well before use.
2. Place a few drops on a swab or rag.
3. Clean the firearm with these swabs and rags until they come out clean.
4. Take a swab or rag and apply a fresh, light coat.

**CAUTION: Don't "dry clean" your firearm. Do not use hot water or other solvents or you will wash away the Teflon lubricant that has been building up as a result of your using CLP. If CLP is not used, RBC may be used to remove carbon.**

General Cleaning is required under normal conditions and the following procedures apply.

1. Always clean after firing, after the firearm is wet or in adverse weather conditions. Remove areas of powder fouling, debris and grit, corrosion and dirt. Clean the bore with a bore brush and a cable cleaning rod. Pull the brush from the chamber to the muzzle. Complete this several times with bore cleaner and let soak several minutes if time permits. Clean the chamber with the chamber brush and a solid cleaning rod handle. Rotate the chamber brush with bore cleaner by pushing and twisting and also let it soak for several minutes while the upper receiver, piston, piston rod and bolt carrier assembly are cleaned with the all purpose brush using bore cleaner. Wipe excess cleaner off with a rag and then run several patches through the bore with the cable rod from the chamber to the muzzle until there is no residue on the patch.
2. Use an all purpose nylon brush or swab and apply a light coat of lubrication with a clean swab to all the metal surfaces, including the bore, the locking lugs in the chamber and on the bolt. A drop of oil should be placed on the ejector, extractor, cam pin, trigger pin, hammer pin, charging handle spring and forward assist.
3. If the firearm has been disassembled, then all parts should be thoroughly **cleaned** and lubricated before assembly. This is the best time to inspect all the parts before assembly.

### LUBRICATION

All firearms require proper lubrication to function as designed and the MR762A1 is no exception. Absence of lubrication may impede the operation of the MR762A1, particularly in load-bearing or friction contact areas. Excessive lubrication may also cause function problems by acting as a magnet for dirt, grit, sand, and fouling. Many high quality, medium weight lubricants (oils) specifically designed for use on firearms, including those cited in the "NOTE" on page 38 will work well on the MR762A1. Do not use lubricants that boast of their ability to penetrate metal as these substances may deaden cartridge primers.

### UPPER RECEIVER

1. Apply a light coat of a suitable CLP (Cleaner Lubricant Preservative) to the interior of the upper receiver, bore and chamber, barrel nut, outer surfaces of barrel, barrel nut, surfaces under handguard and forward assist.

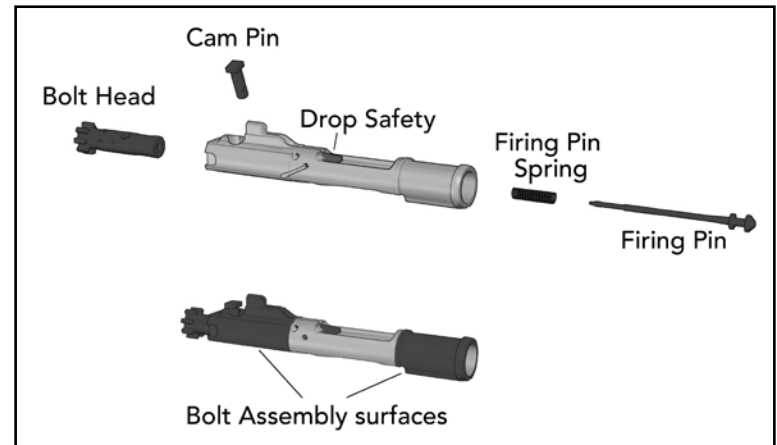

Fig. 56 – Lubrication of the MR762A1 Bolt Carrier Assembly

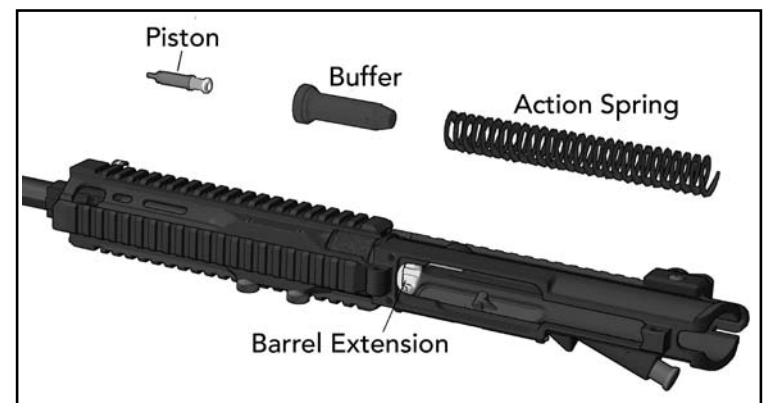

Fig. 57 – Lubrication of the Gas Piston, Piston Rod, and Barrel Nut Exterior

2. Apply a medium coat of CLP on the gas piston and operating rod.
3. Apply a light coat of CLP to the firing pin, firing pin spring, and firing pin recess in bolt (Fig 56).
4. Apply a medium coat of CLP to the extractor (on the front of the bolt head).
5. Apply a heavy coat of CLP to the exterior of the bolt carrier, outside of the firing pin retaining pin, cam pin, and bolt head. Pay special attention to cam pin area inner and outer surfaces of bolt carrier, anvil, and bolt head's locking lug.

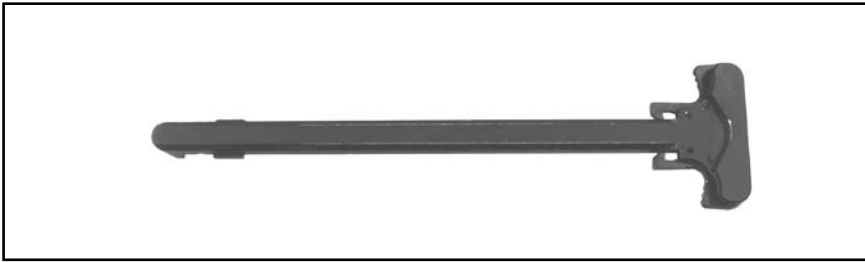

Fig. 58 – Lubrication of MR762A1 Charging Handle

6. Apply a medium coat of CLP to the interior and exterior surfaces of the charging handle (Fig. 58).

#### LOWER RECEIVER ASSEMBLY

1. Apply a light coat of CLP to the exterior of the receiver and receiver extension (buffer tube), exterior metallic surfaces, and exposed pins.
2. Apply a medium coat of CLP to takedown pins, pivot pins, detents, inside the buffer extension tube, buffer detent pin, springs inside the lower receiver, trigger mechanism, hammer, disconnecter, and sear inside the lower receiver.
3. Apply a medium coat of CLP on the (recoil) action spring, buffer.



Fig. 59 – Lubrication of MR762A1 Lower Receiver Assembly

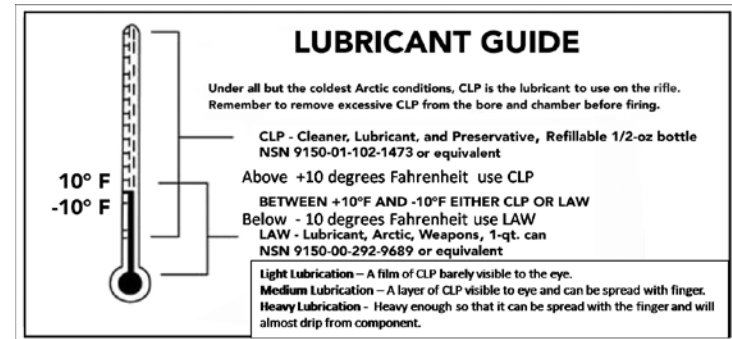

Fig. 60 – MR762A1 Lubricant Guide

#### LUBRICATION SUMMARY

NO Lubrication: (surface is dry and not slippery to the touch)

- Plastic or rubber components
- Sling webbing
- Optics

#### LUBRICATION

- Gas Piston and Gas Cylinder,
- Buffer and recoil spring
- Bolt, Bolt carrier, Cam pin and Firing Pin Safety
- Extractor
- Ejector
- Barrel extension
- Bore, chamber, locking surfaces of the chamber and bolt lugs
- Receiver take down and pivot pin
- Hammer, trigger, disconnecter springs and selector lever in trigger group
- Piston rod
- All metal parts and/or any area where metal contacts metal.

#### Cleaning (HK Magazine)

There are no special requirements, cleaners or lubricants for cleaning this magazine. The standard cleaning equipment that is used for the rifle may be used for this magazine. Refer to the care and cleaning section of this operator's manual for more detailed information. Do not use metal bristle (brass or steel) or wire brushes to clean the magazine components as damage may occur to the protective qualities of the surface finish.

Cleaning may be completed using dry cleaning solvent, bore cleaner, wiping with a cloth or an all purpose nylon brush. Using these guidelines will determine which applies. Cleaning materials are pipe cleaners, swabs, all purpose nylon brush and rags.

**NOTE: If cleaning is completed using a solvent, then a coat of lubricant must be applied for protection against rust and the elements. Dry cleaning solvent may be used to completely remove lubricants. For example, when moving to extreme cold weather operations, dry cleaning solvent may be used to remove traces of CLP before applying LAW.**

The following lubricants (or their commercial equivalents) can be used on this magazine: CLP (Cleaner, Lubricant, and Preservative), LSA (Lubricant, Small Arms) or LAW (Lubricant, Arctic Weather).

CLP does three things at once:

1. It contains solvents to dissolve firing residue and carbon.
2. It lays down a layer of Teflon as it dries to provide lubrication.
3. It prevents rust from forming.

Use CLP as follows:

1. Always shake bottle well before use.
2. Place a few drops on a swab or rag.
3. Clean the magazine with these swabs and rags until they come out clean.
4. Take a swab or rag and apply a fresh, light coat.

---

**CAUTION: Don't "dry clean" your magazines. Do not use hot water or other solvents or you will wash away the Teflon lubricant that has been building up as a result of your using CLP. If CLP is not used, Rifle Bore Cleaner (RBC) may be used to remove carbon.**

---

General cleaning is required under normal conditions and the following procedures apply:

1. Always clean after firing, after magazine is wet or in adverse weather conditions. Remove areas of powder fouling, debris and grit, corrosion and dirt.
2. If magazine is assembled, clean carbon off of follower and feed lips with the all purpose nylon brush or swab and apply a light coat of lubrication with a clean swab.

If the magazine has been disassembled, then all parts should be thoroughly cleaned and lubricated before assembly.

---

**NOTE: Do not mix lubricants on the same magazine. The magazine must be thoroughly cleaned during the change from one lubricant to another. Dry cleaning solvent is recommended for cleaning during the change from one lubricant to another.**

---

#### Lube guide

Under all but the coldest Arctic conditions, CLP is the lubricant to use on your magazine. Between +10 degrees F (-12°C) and -10 degrees F (-23°C) either CLP or LAW may be used. Below -10 degrees F (-23°C) use LAW.

#### Inspection (HK Magazine)

A visual inspection is recommended each and every time you clean the magazine, the magazine is disassembled, or a problem exists that could be magazine related. The following are guidelines that can help in identifying and solving magazine related problems.

Many problems are very often related to incorrect operator use or maintenance, faulty ammunition and/or problems in the weapon. These areas should be checked for problems at the same time the magazine is inspected. If the same problem exists with more than one magazine, then more than likely it is a rifle, operator or ammunition problem. When problems do occur, mark/identify the suspect magazine with a tag or paint/grease pen and use the following as a guideline. Check for proper assembly. Inspect overall function of follower (free movement), locking tabs, dents, cracks, etc.

1. Housing: Inspect feed lips for dents and proper spacing, sides for dents, magazine catch area for worn surfaces or dents, cracks, etc.

2. Follower: Inspect for free movement inside of housing, dents, cracks and deformities.
3. Spring: Inspect for bends, cracks, weak tension.
4. Locking Plate: Inspect for worn or broken tabs. It should retain floor plate and stay securely attached to the spring.
5. Floor plate: Inspect for bends, cracks and correct fit of the locking tabs into the locking recess of housing.
6. Rubber bumper: Insure bumper retains floor plate into housing when assembled and there are no signs of extreme wear.

If any problems are identified, repair or replace as necessary.

## SECTION 9 — TROUBLESHOOTING PROBLEMS AND REPAIR

This section contains operator level troubleshooting information for locating and correcting most of the operating troubles which may develop in the MR762A1 Series. Each malfunction for the individual part or assembly is followed by a list of tests or inspections which will help you to determine the corrective actions in the order listed. This manual cannot list all malfunctions that may occur, or all tests or inspections and corrective actions.

If a malfunction is not listed or is not corrected by listed corrective actions, please contact Heckler & Koch Customer Service staff. The symptom index is provided for a quick reference of the malfunctions covered in the table. The MR762A1 must always be treated as if loaded until the stoppage has been cleared. The following list does not include all potential causes and/or corrective actions. Other causes than those indicated below may be encountered.

Malfunction	Probable Cause	Corrective Action
<b>Failure of magazine to lock in rifle.</b>	Dirty or corroded magazine catch.	Disassemble and clean.
	Worn or broken magazine catch.	Contact HK certified armorer.
	Defective magazine catch spring.	Contact HK certified armorer.
<b>Failure to feed.</b>	Short recoil.	Refer to short recoil.
	Magazine catch out of adjustment (will not retain magazine).	Contact HK certified armorer.
	Magazine catch spring weak or broken.	Contact HK certified armorer.
	Magazine catch defective. Magazine improperly filled.	Contact HK certified armorer. Remove rounds and reinsert
<b>Failure to chamber.</b>	Short recoil.	Refer to short recoil.
	Weak or broken recoil spring.	Contact HK certified armorer.
<b>Failure to lock.</b>	Improperly assembled extractor spring assembly.	Assemble correctly.
	Bolt cam pin missing.	User should replace.
	Bent piston rod.	User should replace.
	Weak or broken recoil spring.	User should replace.
<b>Failure to fire.</b>	Carbon buildup in firing pin recess inside bolt assembly.	Remove firing pin & clean recess with pipe cleaner. Refer to operator's manual under cleaning.
	Broken or chipped firing pin.	Contact HK certified armorer.
	Broken, defective, or missing firing pin retaining pin.	Contact HK certified armorer.
	Firing mechanism and or lower receiver improperly assembled or has worn, broken, or missing parts.	Contact HK certified armorer.

Malfunction	Probable Cause	Corrective Action
<b>Failure to unlock.</b>	Short recoil.	Refer to short recoil.
	Burred locking lugs on bolt assembly.	Contact HK certified armorer.
	Burred lugs on barrel extension.	Contact HK certified armorer.
<b>Failure to extract.</b>	Defective extractor pin, extractor, and/or extractor spring assembly.	Contact HK certified armorer.
<b>Failure to eject.</b>	Short recoil.	Refer to short recoil.
	Ejector stuck in bolt body.	Contact HK certified armorer.
	Broken ejector.	Contact HK certified armorer
	Weak or broken ejector spring.	Contact HK certified armorer
<b>Failure to cock.</b>	Short recoil.	Refer to short recoil.
	Worn, broken, or missing parts of firing mechanism.	Contact HK certified armorer
<b>Short recoil.</b>	Unlubricated or dirty recoil spring and receiver extension.	Clean and lubricate.
	Broken or damaged recoil spring.	Contact HK certified armorer
	Worn, missing, or broken piston rings.	Contact HK certified armorer
<b>Rifle cannot be zeroed.</b>	Loose front/rear sight base.	Tighten bases down.
	Defective rear sight assembly.	Contact HK certified armorer
	Defective front sight.	Contact HK certified armorer
	Defective barrel assembly. Barrel assembly out of alignment with rear sight assembly on upper receiver. Loose barrel.	Contact HK certified armorer
	Worn, broken, or missing parts of firing mechanism.	Contact HK certified armorer
<b>Fires with selector lever on SAFE or when trigger is released with selector lever on SEMI-AUTO</b>	Worn, broken, or missing parts of firing mechanism.	Contact HK certified armorer

SECTION 10 — EXPLODED DIAGRAM AND PARTS LIST

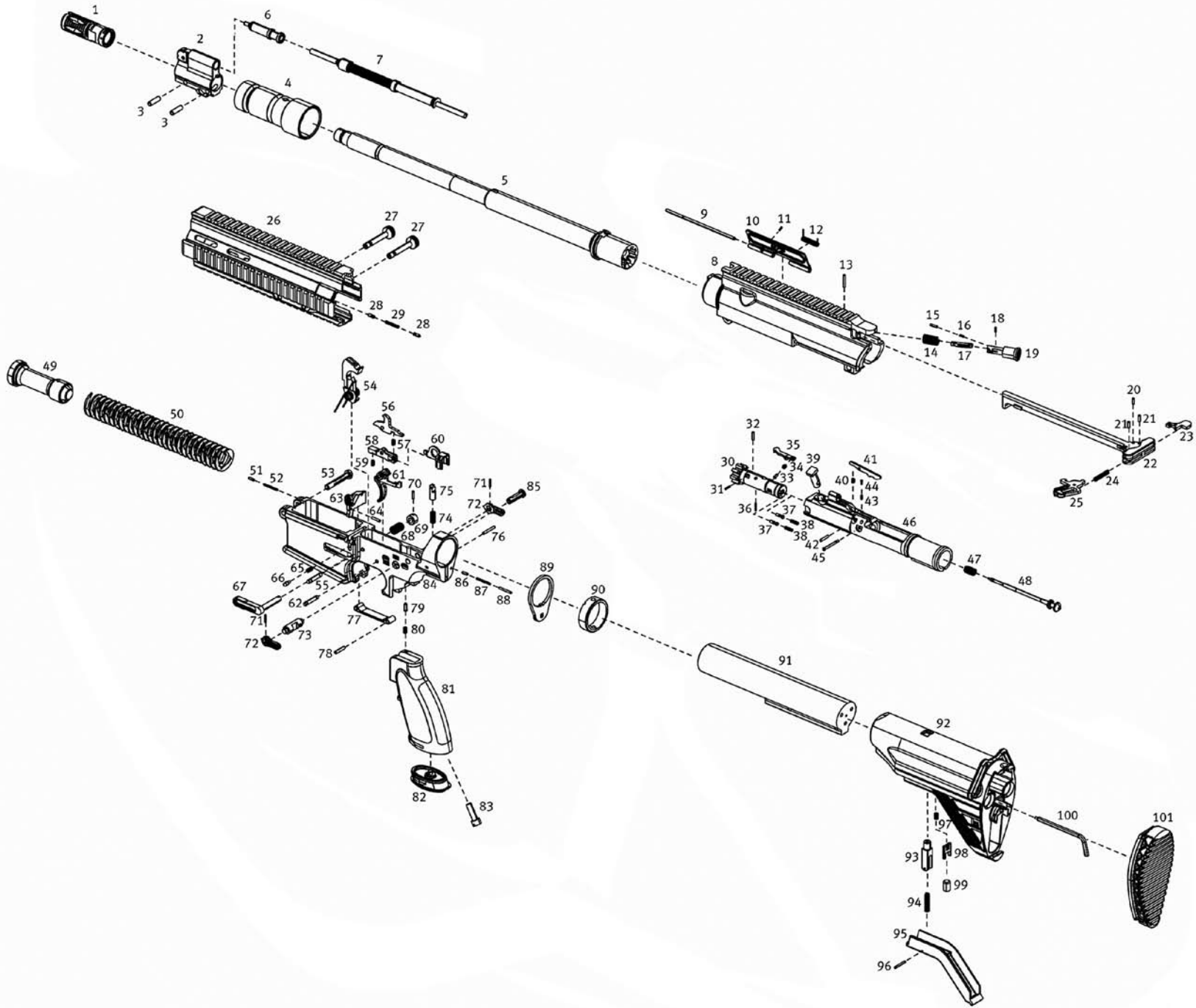



**PARTS LIST (FOR EXPLODED DIAGRAM, PAGES 42-43)**

Item	Description	Part Number	Item	Description	Part Number
MR762 A1	(Item 1 - 101)	235 974	60	Bridge	203 593
—	Upper receiver, compl. (Item 1 - 19)	235 993	61	Trigger	235 732
—	Barrel MR762 16.5", compl. (Item 1 - 5)	235 999	62	Axle for trigger	227 886
1	Flash hider, compl.	237 016	63	Bolt catch/release	233 785
2	Gas block	235 880	64	Clamping sleeve for bolt catch/release	979 292
3	Clamping sleeve for gas block (2x)	978 330	65	Pressure spring for pressure pin	233 132
4	Barrel nut	233 791	66	Pressure pin	233 131
5	Barrel MR762 16.5", assembled	236 201	67	Magazine catch	227 689
6	Gas piston, compl.	205 381	68	Pressure spring for retainer	233 716
7	Rod, compl.	203 648	69	Retainer for magazine catch	233 793
8	Upper receiver, assembled	235 984	70	Clamping sleeve for retainer	928 077
9	Axle for cover	233 787	71	Clamping sleeve for safety lever (2x)	984 199
10	Ejection port cover, compl.	233 808	72	Safety lever (2x)	227 870
11	Clamping sleeve	928 807	73	Safety roller	236 274
12	Elbow spring	235 012	74	Pressure spring for locking pin	233 121
13	Clamping sleeve for forward assist	979 313	75	Locking pin for buffer	233 120
14	Pressure spring for forward assist	203 635	76	Clamping sleeve for locking pin	986 544
—	Forward assist, compl. (Item 15-19)	203 599	77	Trigger guard, compl.	233 153
15	Pressure bolt for forward assist	203 637	78	Clamping sleeve for trigger guard	979 294
16	Pressure spring for pressure bolt	203 636	79	Stop pin	236 687
17	Locking piece for forward assist	203 601	80	Pressure spring for stop pin	233 136
18	Pressure bolt for locking piece	979 293	—	Pistol grip, compl. (Item 81-82)	234 671
19	Retainer, compl.	203 600	81	Pistol grip	234 672
—	Charging handle, compl. (Item 20-25)	227 491	82	Cover, compl.	234 668
20	Clamping sleeve (2x)	984 198	83	Cylindrical screw	979 355
21	Clamping sleeve for plate	928 390	84	Lower receiver	235 988
22	Charging handle	233 779	85	Locking pin, compl.	235 931
23	Plate	227 613	86	Stop pin for locking pin	233 115
24	Pressure spring	227 638	87	Pressure spring	233 116
25	Pawl, compl.	236 347	88	Cylindrical pin for stop pin	978 316
—	Handguard, compl. (Item 26 -29)	235 870	89	Plate	233 770
26	Handguard	235 874	90	Nut for extension	233 769
27	Locking screw for handguard (2x)	236 203	91	Extension for buttstock, compl.	227 473
28	Grooved bolt (2x)	233 802	—	Buttstock concave, compl. (Item 92-101)	236 624
29	Pressure spring	233 087	—	Buttstock, assembled (Item 92-99)	235 917
—	Bolt group, compl. (Item 30-48)	236 591	92	Buttstock	235 918
—	Bolt head, compl. (Item 30-38)	236 592	93	Bolt	227 378
30	Bolt head	235 878	94	Pressure spring	234 688
31	Axle for extractor	971 919	95	Release lever	235 920
32	Clamping sleeve	233 790	96	Clamping sleeve	968 761
33	Rubber plug	207 779	97	Pressure spring	212 846
34	Pressure spring	205 407	98	Insert	235 919
35	Extractor	233 764	99	Threaded pin	967 662
36	Clamping sleeve	984 199	100	Hexagonal Allen key	235 932
37	Ejector (2x)	205 408	101	Buttstock cap, concave	227 616
38	Pressure springs for ejector (2x)	209 531			
39	Control bolt	233 759			
—	Bolt head carrier, compl. (Item 40-46)	236 297			
40	Pressure spring	205 407			
41	Catch	233 761			
42	Clamping sleeve for catch	984 153			
43	Compression spring	235 022			
44	Bolt	235 238			
45	Pin	235 888			
46	Bolt head carrier	236 298			
47	Pressure spring for firing pin	233 674			
48	Firing pin	235 654			
—	Lower receiver, compl. (Item 49-101)	235 986			
49	Buffer, compl.	233 777			
50	Recoil spring	233 760			
—	Lower receiver, assembled (Item 51-84)	235 987			
51	Stop pin for locking pin	233 115			
52	Pressure spring	233 116			
53	Locking pin, compl.	235 930			
54	Hammer, compl.	227 693			
55	Axle for hammer	235 346			
56	Disconnecter	227 695			
57	Pressure spring	233 149			
58	Sear release rocker	235 731			
59	Pressure spring	235 000			

**SECTION 11 — SPECIFICATIONS**

Caliber	7.62 x 51 mm NATO
Operating principle	Gas operated, short stroke piston
Bolt system	Rotating bolt
Feed mechanism	Magazines, 10/20 rounds
Mode of fire	Semi-automatic

Dimensions	
Length, maximum (stock extended)	39.50 in / 1003 mm
Length, minimum (stock retracted)	36.00 in / 914 mm
Width	3.23 in / 82 mm
Height	8.39 in / 213 mm
Barrel length	16.5 in / 421 mm

Weight	
Rifle (with empty magazine)	9.94 lb / 4.5 kg
Magazine (empty 10 round magazine)	.34 lb / .15 kg

Other	
Trigger pull (Two-stage trigger)	20-25 N ( approximate)
Barrel profile	lands & grooves, 4 grooves, right twist, 1 in 11 in (280 mm)
Adjustable buttstock	5 positions, 80 mm of travel

NOTE: Different sights and optics can be mounted on the HK Free Floating Rail System (Picatinny type, MIL-STD-1913), all specifications and technical data subject to modification

**WARRANTY REGISTRATION**

Heckler & Koch warranty registration for new firearms is now on-line. To register your new MR762A1 go to...<http://hk-usa.com/warranty/register.html>

If you don't have access to the internet, call HK Customer Service at 706-568-1906 to obtain a warranty card.

Every attempt has been made to ensure the accuracy of this information, however errors or changes may occur.





---

**HECKLER & KOCH**  
5675 Transport Boulevard  
Columbus, Georgia 31907  
United States of America  
Tel: (706) 568-1906  
Fax: (706) 568-9151  
USA Website: [www.hk-usa.com](http://www.hk-usa.com)

**HECKLER & KOCH**  
D-78722 Oberndorf/Neckar  
Postfach 1329  
Germany  
Tel: 011-49-7423/79-0  
Fax: 011-49-7423/2280  
Global Website: [www.heckler-koch.com](http://www.heckler-koch.com)